

# Chapter 6: External Photon Beams: Physical Aspects

Set of 170 slides based on the chapter authored by  
E.B. Podgorsak  
of the IAEA textbook:

*Radiation Oncology Physics:  
A Handbook for Teachers and Students*

## Objective:

To familiarize the student with the basic principles of dose calculations in external beam radiotherapy with photon beams.



Slide set prepared in 2006  
by E.B. Podgorsak (Montreal, McGill University)  
Comments to S. Vatnitsky:  
[dosimetry@iaea.org](mailto:dosimetry@iaea.org)

## CHAPTER 6. TABLE OF CONTENTS

- 6.1. Introduction
- 6.2. Quantities used in describing a photon beam
- 6.3. Photon beam sources
- 6.4. Inverse square law
- 6.5. Penetration of photon beams into a phantom or patient
- 6.6. Radiation treatment parameters
- 6.7. Central axis depth doses in water: SSD set-up
- 6.8. Central axis depth doses in water: SAD set-up
- 6.9. Off-axis ratios and beam profiles
- 6.10. Isodose distributions in water phantoms
- 6.11. Single field isodose distributions in patients
- 6.12. Clarkson segmental integration
- 6.13. Relative dose measurements with ionization chambers
- 6.14. Delivery of dose with a single external beam
- 6.15. Shutter correction time

## 6.1 INTRODUCTION

- ❑ Radiotherapy also referred to as **radiation oncology** or **therapeutic radiology** is a branch of medicine that uses **ionizing radiation** in treatment of malignant disease.
- ❑ Radiotherapy is divided into two categories:
  - External beam radiotherapy
  - Brachytherapy

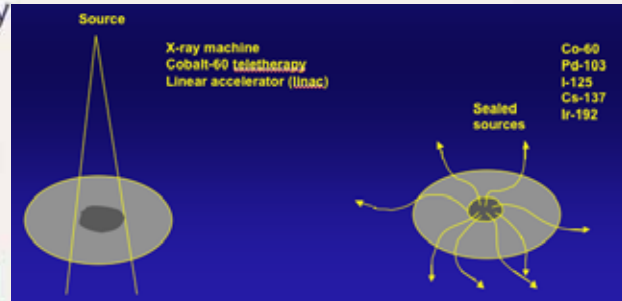
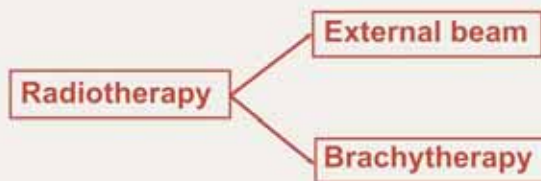

## 6.1 INTRODUCTION

- ❑ Ionizing photon radiation
  - **Gamma rays** (originates in nuclear gamma decay)  
Used in teletherapy machines
  - **Bremsstrahlung** (electron - nucleus Coulomb interaction)  
Used in x-ray machines and linacs
  - **Characteristic x rays** (electron - orbital electron interaction)  
Used in x-ray machines and linacs
  - **Annihilation radiation** (positron annihilation)  
Used in positron emission tomography (PET) imaging



## 6.2 QUANTITIES USED IN DESCRIBING PHOTON BEAMS

□ **Radiation dosimetry** deals with two distinct entities:

- Description of photon radiation beam in terms of the number and energies of all photons constituting the beam (**photon beam spectrum**).
- Description of the amount of energy per unit mass (**absorbed dose**) the photon beam may deposit in a given medium, such as air, water, or biological material.



## 6.2 QUANTITIES USED IN DESCRIBING PHOTON BEAMS

### 6.2.1 Photon fluence and photon fluence rate

□ **Photon fluence**  $\phi = \frac{dN}{dA}$

- $dN$  is the number of photons that enter an imaginary sphere of cross-sectional area  $dA$ .
- Unit of photon fluence is  $\text{cm}^{-2}$ .

□ **Photon fluence rate**  $\dot{\phi} = \frac{d\phi}{dt}$  is defined as photon fluence per unit time.

- Unit of photon fluence rate is  $\text{cm}^{-2} \cdot \text{s}^{-1}$ .



## 6.2 QUANTITIES USED IN DESCRIBING PHOTON BEAMS

### 6.2.2 Energy fluence and energy fluence rate

□ Energy fluence  $\psi = \frac{dE}{dA}$

- $dE$  is the amount of energy crossing a unit area  $dA$ .
- Unit of energy fluence  $\psi$  is  $\text{MeV} \cdot \text{cm}^{-2}$

□ Energy fluence rate  $\Psi = \dot{\psi} = \frac{d\psi}{dt}$  is defined as the energy fluence  $\psi$  per unit time.

- Unit of energy fluence rate  $\Psi$  is  $\text{MeV} \cdot \text{cm}^{-2} \cdot \text{s}^{-1}$



## 6.2 QUANTITIES USED IN DESCRIBING PHOTON BEAMS

### 6.2.3 Air kerma in air

- For a monoenergetic photon beam in air the **air kerma in air**  $(K_{\text{air}})_{\text{air}}$  at a given point away from the source is

$$(K_{\text{air}})_{\text{air}} = \psi \left( \frac{\bar{\mu}_{\text{tr}}}{\rho} \right)_{\text{air}} = \phi h\nu \left( \frac{\bar{\mu}_{\text{tr}}}{\rho} \right)_{\text{air}}$$

$(\bar{\mu}_{\text{tr}}/\rho)$  is the mass-energy transfer coefficient for air at photon energy  $h\nu$ .



## 6.2 QUANTITIES USED IN DESCRIBING PHOTON BEAMS

### 6.2.3 Air kerma in air

- Kerma consists of two components: collision and radiation

$$K = K^{\text{col}} + K^{\text{rad}}$$

- Collision kerma  $K^{\text{col}}$  is proportional to photon fluence  $\phi$  and energy fluence  $\psi$

$$K^{\text{col}} = \psi \left( \frac{\mu_{\text{ab}}}{\rho} \right) = \phi h\nu \left( \frac{\mu_{\text{ab}}}{\rho} \right)$$

$(\bar{\mu}_{\text{ab}}/\rho)$  is the mass-energy absorption coefficient for air at photon energy  $h\nu$ .



## 6.2 QUANTITIES USED IN DESCRIBING PHOTON BEAMS

### 6.2.3 Air kerma in air

- Relationship between  $(\bar{\mu}_{\text{ab}}/\rho)$  and  $(\bar{\mu}_{\text{tr}}/\rho)$

$$\frac{\mu_{\text{ab}}}{\rho} = \frac{\mu_{\text{tr}}}{\rho} (1 - \bar{g})$$

$\bar{g}$  is the radiation fraction, i.e., fraction of charged particle energy lost to bremsstrahlung rather than being deposited in the medium.



## 6.2 QUANTITIES USED IN DESCRIBING PHOTON BEAMS

### 6.2.4 Exposure in air

- Collision air kerma in air  $(K_{\text{air}}^{\text{col}})_{\text{air}}$  and exposure in air  $X$

$$(K_{\text{air}}^{\text{col}})_{\text{air}} = X \left( \frac{\bar{W}_{\text{air}}}{e} \right) \quad (\bar{W}_{\text{air}}/e) = 33.97 \text{ J/C.}$$

$(\bar{W}_{\text{air}}/e)$  is the average energy required to produce an ion pair in dry air.

- Special unit of exposure is the roentgen R

$$1 \text{ R} = 2.58 \times 10^{-4} \text{ C/kg}_{\text{air}}$$

- $(K_{\text{air}}^{\text{col}})_{\text{air}} = \left( 2.58 \times 10^{-4} \frac{\text{C}}{\text{kg}_{\text{air}}} 33.97 \frac{\text{J}}{\text{C}} \right) X = \left( 0.876 \frac{\text{cGy}}{\text{R}} \right) X$



## 6.2 QUANTITIES USED IN DESCRIBING PHOTON BEAMS

### 6.2.5 Dose to small mass of medium in air

- The concept “dose to small mass of medium in air”  $D'_{\text{med}}$  also referred to as “dose in free space” is based on measurement of air kerma in air.

- $D'_{\text{med}}$  is subject to same limitations as exposure  $X$  and collision air kerma in air  $(K_{\text{air}}^{\text{col}})_{\text{air}}$

- Defined only for photons.
- Defined only for photon energies below 3 MeV.



## 6.2 QUANTITIES USED IN DESCRIBING PHOTON BEAMS

### 6.2.5 Dose to small mass of medium in air

- $D'_{\text{med}}$  is determined from ionization chamber signal measured at point P in air.
  
- The ionization chamber must:
  - Incorporate appropriate buildup cap
  - Possess an exposure calibration coefficient  $N_X$  or air kerma in air calibration coefficient  $N_K$ .



## 6.2 QUANTITIES USED IN DESCRIBING PHOTON BEAMS

### 6.2.5 Dose to small mass of medium in air

- Steps involved in the determination of  $D'_{\text{med}}$  from  $M_P$

$$M_P \rightarrow X_P \rightarrow (K_{\text{air}})_{\text{air}} \rightarrow (K_{\Delta m})_{\text{air}} \rightarrow (K_{\text{med}})_{\text{air}} \rightarrow D'_{\text{med}}$$

Step: (1) (2) (3) (4) (5)

- $M_P$  signal measured at point P in air.
- $X_P$  exposure at point P in air.
- $(K_{\text{air}})_{\text{air}}$  air kerma in air at point P.
- $(K_{\Delta m})_{\text{air}}$  collision kerma to  $\Delta m$ , an infinitesimal mass of medium at P.
- $(K_{\text{med}})_{\text{air}}$  collision kerma to a spherical mass of medium with radius  $r_{\text{med}}$  at P.
- $D'_{\text{med}}$  dose to small mass of medium at point P.



## 6.2 QUANTITIES USED IN DESCRIBING PHOTON BEAMS

### 6.2.5 Dose to small mass of medium in air

- Steps involved in the calculation of  $D'_{\text{med}}$

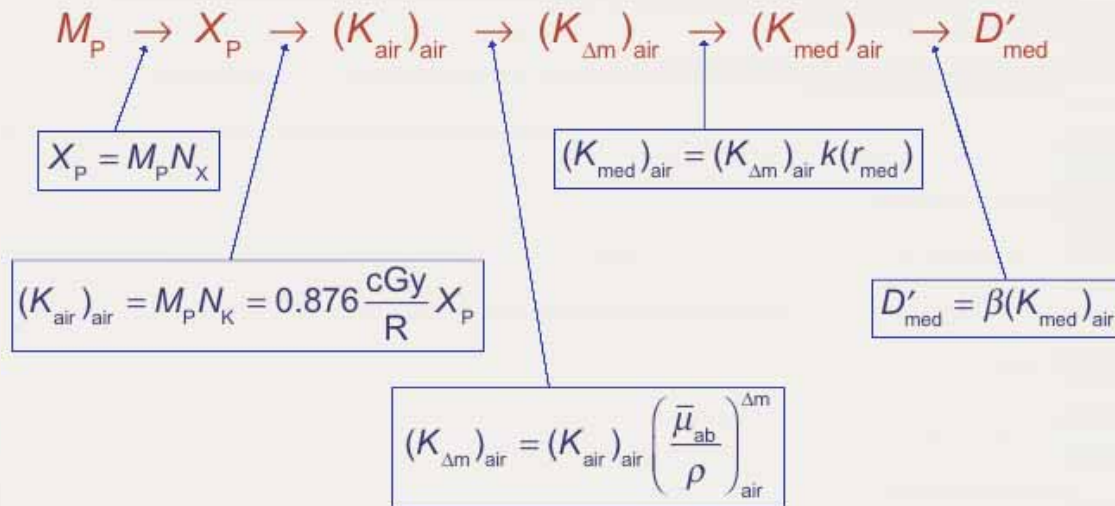

## 6.2 QUANTITIES USED IN DESCRIBING PHOTON BEAMS

### 6.2.5 Dose to small mass of medium in air

- Determination of  $D'_{\text{med}}$

$$D'_{\text{med}} = \beta \left\{ 0.876 \frac{\text{cGy}}{\text{R}} \left( \frac{\bar{\mu}_{\text{ab}}}{\rho} \right)_{\text{air}}^{\Delta m} \right\} k(r_{\text{med}}) X_P \approx f_{\text{med}} k(r_{\text{med}}) X_P$$

- $k(r_{\text{med}})$  is a **correction factor** accounting for the photon beam attenuation in the spherical mass of medium with radius  $r_{\text{med}}$  just large enough to provide electronic equilibrium at point P.

- $k(r_{\text{med}})$  is given by:  $k(r_{\text{med}}) = e^{-\left( \frac{\bar{\mu}_{\text{ab}}}{\rho} \right)_{\text{med}} \rho r_{\text{med}}}$

- For water as the medium  $k(r_{\text{med}}) = 0.985$  for cobalt-60 gamma rays and equal to 1 for lower photon energies.





## 6.3 PHOTON SOURCES FOR EXTERNAL BEAM THERAPY

- ☐ Photon sources with regard to **type of photons**:
  - Gamma ray sources
  - X-ray sources
- ☐ Photon sources with regard to **photon energies**:
  - Monoenergetic sources
  - Heterogeneous sources
- ☐ Photon sources with regard to **intensity distribution**:
  - Isotropic
  - Non-isotropic



## 6.3 PHOTON SOURCES FOR EXTERNAL BEAM THERAPY

- ☐ For a given photon source, a plot of number of photons per energy interval versus photon energy is referred to as photon spectrum.

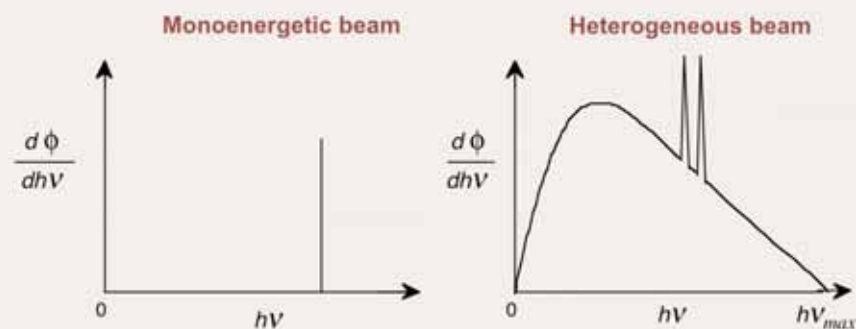

- ☐ All photons in a monoenergetic photon beam have the same energy  $h\nu$ .



## 6.3 PHOTON SOURCES FOR EXTERNAL BEAM THERAPY

☐ Photons in a **heterogeneous x-ray beam** form a distinct spectrum,

- Photons are present in all energy intervals from 0 to a maximum value  $h\nu_{\max}$  which is equal to the monoenergetic kinetic energy of electrons striking the target.

- The two spikes in the spectrum represent **characteristic x rays**; the continuous spectrum from 0 to  $h\nu_{\max}$  represents **bremsstrahlung photons**.

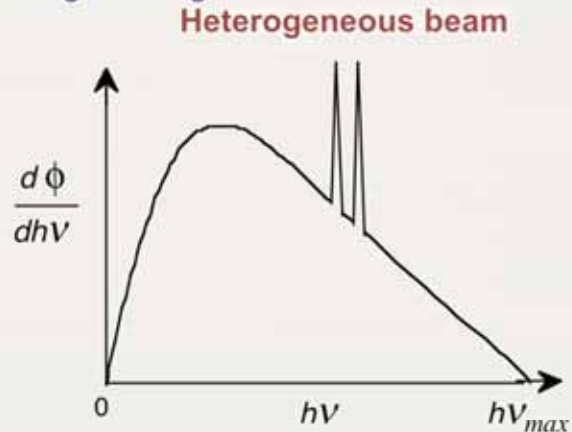

## 6.3 PHOTON SOURCES FOR EXTERNAL BEAM THERAPY

☐ **Gamma ray sources** are usually **isotropic** and produce monoenergetic photon beams.

☐ **X-ray targets** are **non-isotropic sources** and produce heterogeneous photon spectra.

- In the superficial and orthovoltage energy region the x-ray emission occurs predominantly at  $90^\circ$  to the direction of the electron beam striking the x-ray target.
- In the megavoltage energy region the x-ray emission in the target occurs predominantly in the direction of the electron beam striking the target (forward direction).



## 6.4 INVERSE SQUARE LAW

□ In external beam radiotherapy:

- Photon sources are often assumed to be point sources.
- Beams produced by photon sources are assumed to be divergent.

$$\tan \beta = \frac{a/2}{f_a} = \frac{b/2}{f_b}$$

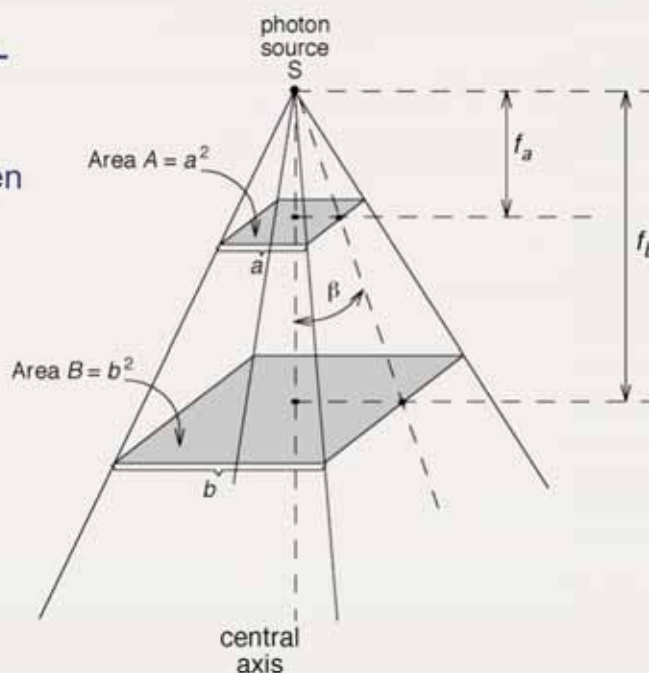

## 6.4 INVERSE SQUARE LAW

□ Photon source S emits photons and produces a photon fluence  $\phi_A$  at a distance  $f_a$  and a photon fluence  $\phi_B$  at distance  $f_b$ .

□ Number of photons  $N_{\text{tot}}$  crossing area A is equal to the number of photons crossing area B.

$$N_{\text{tot}} = \phi_A A = \phi_B B = \text{const}$$

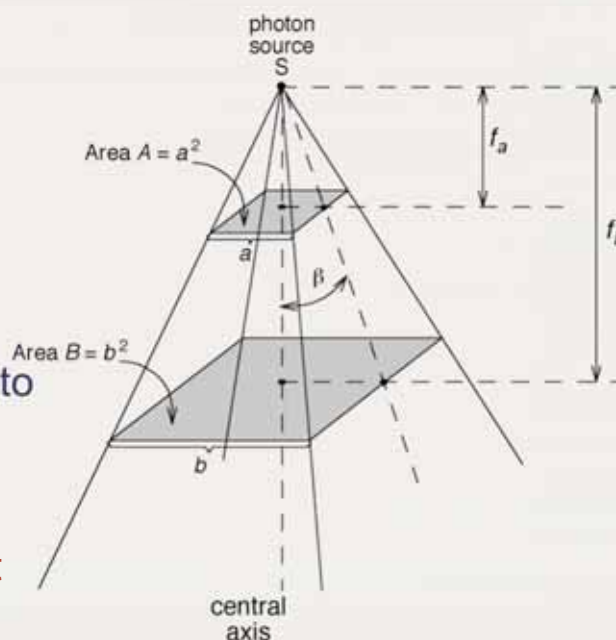

## 6.4 INVERSE SQUARE LAW

- We assume that  $N_{\text{tot}} = \text{const}$ , i.e., no photon interactions take place in air. Therefore:

$$\frac{\phi_A}{\phi_B} = \frac{B}{A} = \frac{b^2}{a^2} = \frac{f_b^2}{f_a^2}$$

$$\frac{X(f_a)}{X(f_b)} = \frac{(K_{\text{air}}^{\text{col}}(f_a))_{\text{air}}}{(K_{\text{air}}^{\text{col}}(f_b))_{\text{air}}} = \frac{D'_{\text{med}}}{D'_{\text{med}}} = \left(\frac{f_b}{f_a}\right)^2$$

$X$ ,  $(K_{\text{air}}^{\text{col}})_{\text{air}}$ , and  $D'_{\text{med}}$

- Quantities all follow the inverse square law.

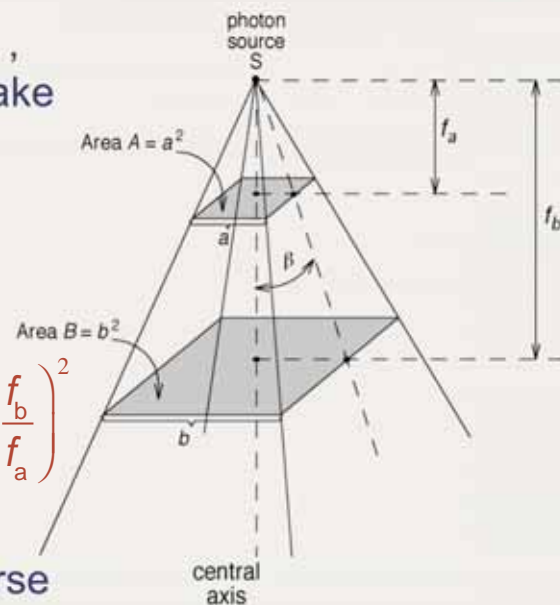

## 6.5 PENETRATION OF PHOTON BEAMS INTO PATIENT

- A photon beam propagating through air or vacuum is governed by the **inverse square law**.
- A photon beam propagating through a phantom or patient is affected not only by the inverse square law but also by the **attenuation and scattering** of the photon beam inside the phantom or patient.
- The three effects make the dose deposition in a phantom or patient a complicated process and its determination a complex task.



## 6.5 PENETRATION OF PHOTON BEAMS INTO PATIENT

- ❑ For a successful outcome of patient radiation treatment it is imperative that the **dose distribution in the target volume and surrounding tissues is known precisely and accurately.**
- ❑ This is usually achieved through the use of several **empirical functions** that link the dose at any arbitrary point inside the patient to the known dose at the beam calibration (or reference) point in a phantom.



## 6.5 PENETRATION OF PHOTON BEAMS INTO PATIENT

- ❑ Dosimetric functions are usually measured with suitable **radiation detectors in tissue equivalent phantoms.**
- ❑ Dose or dose rate at the reference point is determined for, or in, **water phantoms for a specific set of reference conditions, such as:**
  - Depth in phantom  $z$
  - Field size  $A$
  - Source-surface distance (SSD).



## 6.5 PENETRATION OF PHOTON BEAMS INTO PATIENT

- Typical dose distribution for an external photon beam follows a known general pattern:

- The beam enters the patient on the surface where it delivers a certain surface dose  $D_s$ .
- Beneath the surface the dose first rises rapidly, reaches a maximum value at a depth  $z_{max}$ , and then decreases almost exponentially until it reaches a value  $D_{ex}$  at the patient's exit point.

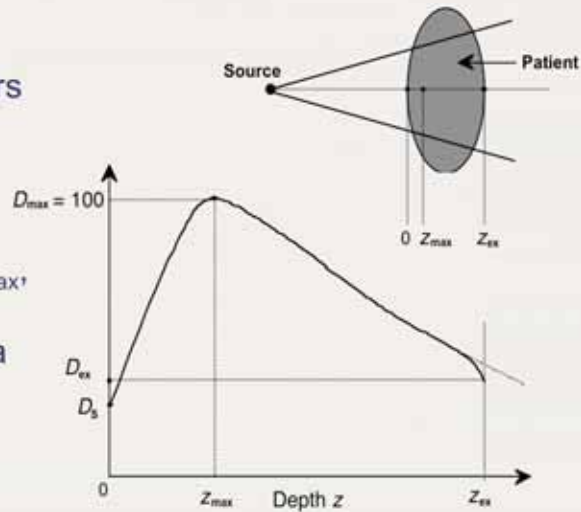

## 6.5 PENETRATION OF PHOTON BEAMS INTO PATIENT

### 6.5.1 Surface dose

- Surface dose:

- For megavoltage x-ray beams the surface dose is generally much lower (skin sparing effect) than the maximum dose at  $z_{max}$ .
- For superficial and orthovoltage beams  $z_{max} = 0$  and the surface dose equals the maximum dose.
- The surface dose is measured with parallel-plate ionization chambers for both chamber polarities, with the average reading between the two polarities taken as the correct surface dose value.

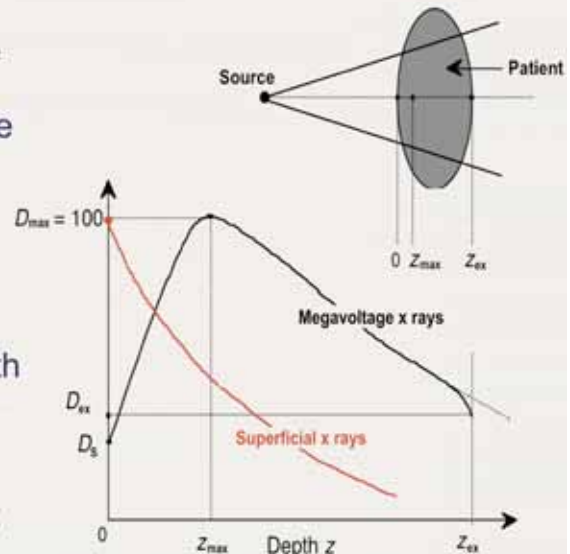

## 6.5 PENETRATION OF PHOTON BEAMS INTO PATIENT

### 6.5.1 Surface dose

#### Contributors to surface dose $D_s$ :

- Photons scattered from the collimators, flattening filter and air.
- Photons backscattered from the patient.
- High energy electrons produced by photon interactions in air and any shielding structures in the vicinity of the patient.

#### Typical values of surface dose:

- 100% superficial and orthovoltage
- 30% cobalt-60 gamma rays
- 15% 6 MV x-ray beams
- 10% 18 MV x-ray beams

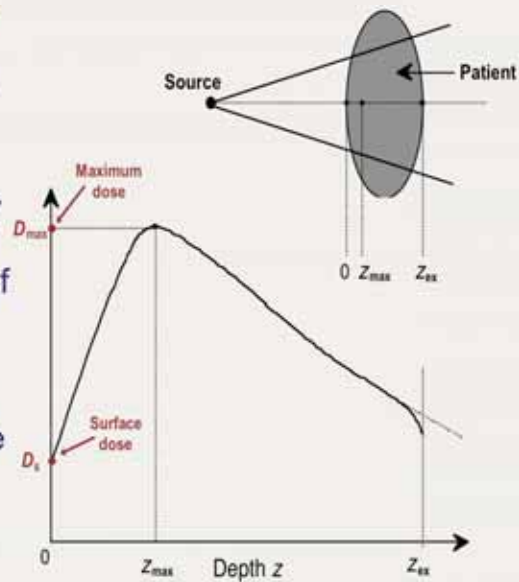

## 6.5 PENETRATION OF PHOTON BEAMS INTO PATIENT

### 6.5.2 Buildup region

#### Buildup dose region:

- The region between the surface ( $z = 0$ ) and depth  $z = z_{max}$  in megavoltage photon beams is called the dose buildup region.
- The dose buildup results from the relatively long range of secondary charged particles that first are released in the patient by photon interactions and then deposit their kinetic energy in the patient through Coulomb interactions.
- CPE does not exist in the dose buildup region.

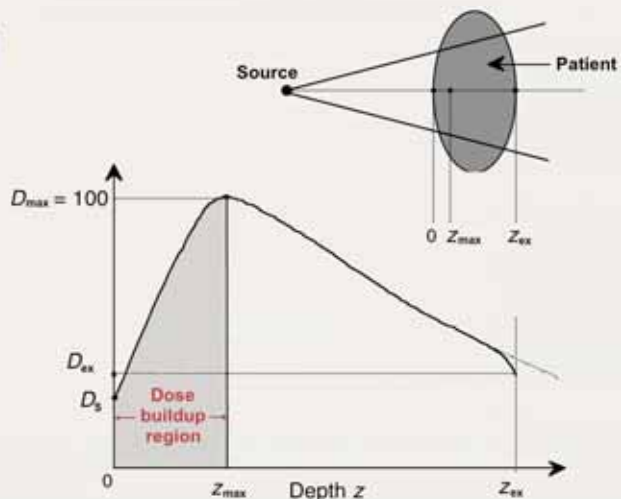



## 6.5 PENETRATION OF PHOTON BEAMS INTO PATIENT

### 6.5.3 Depth of dose maximum

□ Depth of dose maximum  $z_{max}$  depends upon:

- Photon beam energy (main effect)
- Field size (secondary effect)

□ For a given field size:

- $z_{max}$  increases with photon beam energy.
- For 5x5 cm<sup>2</sup> fields, the nominal values of  $z_{max}$  are:

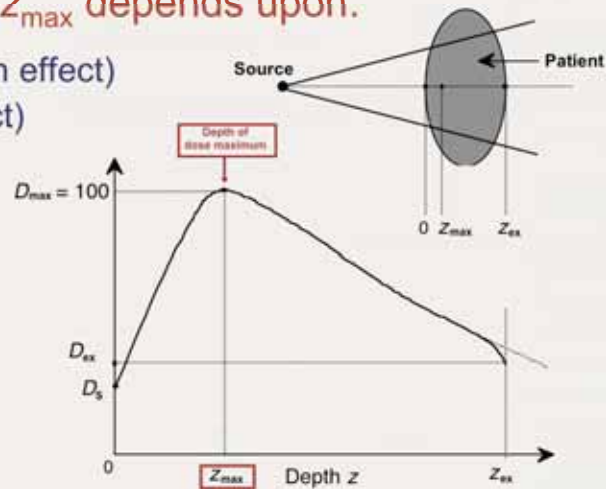

Energy	100 kV <sub>p</sub>	350 kV <sub>p</sub>	Co-60	4 MV	6 MV	10 MV	18 MV
$z_{max}$ (cm)	0	0	0.5	1.0	1.5	2.5	3.5



## 6.5 PENETRATION OF PHOTON BEAMS INTO PATIENT

### 6.5.3 Depth of dose maximum $z_{max}$

□ At a given beam energy:

- For fields smaller than 5x5 cm<sup>2</sup>,  $z_{max}$  increases with increasing field size because of in-phantom scatter.
- For field 5x5 cm<sup>2</sup>,  $z_{max}$  reaches its nominal value.
- For fields larger than 5x5 cm<sup>2</sup>,  $z_{max}$  decreases with increasing field size because of collimator and flattening filter scatter.

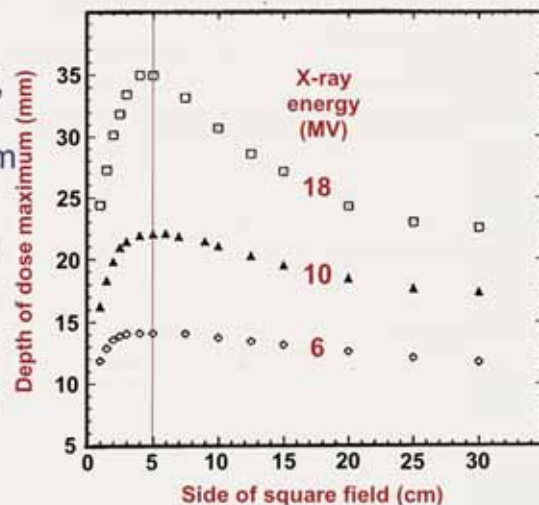



## 6.5 PENETRATION OF PHOTON BEAMS INTO PATIENT

### 6.5.3 Exit dose

- ❑ The dose delivered to the patient at the beam exit point is called the **exit dose**.
- ❑ Close to the beam exit point the dose distribution curves slightly downwards from the dose curve obtained for a infinitely thick phantom as a result of missing scatter contribution for points beyond the dose exit point.
- ❑ The effect is small and generally ignored.

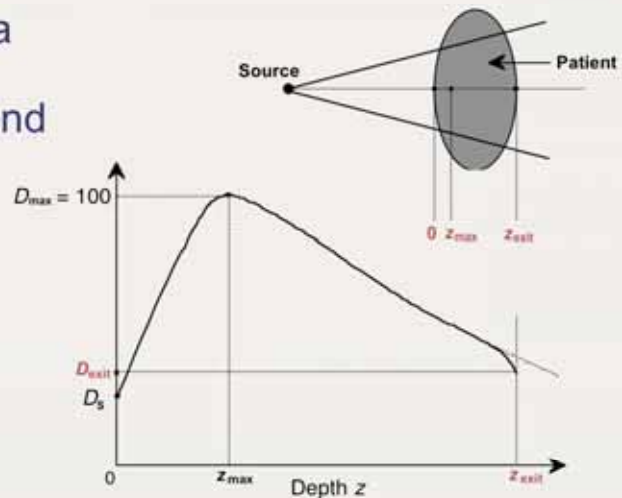

Radiation Oncology Physics: A Handbook for Teachers and Students - 6.5.3 Slide 3



## 6.6 RADIATION TREATMENT PARAMETERS

- ❑ The main parameters in external beam dose delivery with photon beams are:
  - Depth of treatment  $z$
  - Fields size  $A$
  - Source-skin distance (SSD) in SSD setups
  - Source-axis distance (SAD) in SAD setups
  - Photon beam energy  $h\nu$
  - Number of beams used in dose delivery to the patient
  - Treatment time for orthovoltage and teletherapy machines
  - Number of monitor units (MUs) for linacs



Radiation Oncology Physics: A Handbook for Teachers and Students - 6.6 Slide 1

## 6.6 RADIATION TREATMENT PARAMETERS

- ❑ Point P is at  $z_{\max}$  on central axis.
- ❑ Point Q is arbitrary point at depth  $z$  on the central axis.
- ❑ Field size  $A$  is defined on patient's surface.
- ❑  $A_Q$  is the field size at point Q.
- ❑ SSD = source-skin distance.
- ❑ SCD = source-collimator distance

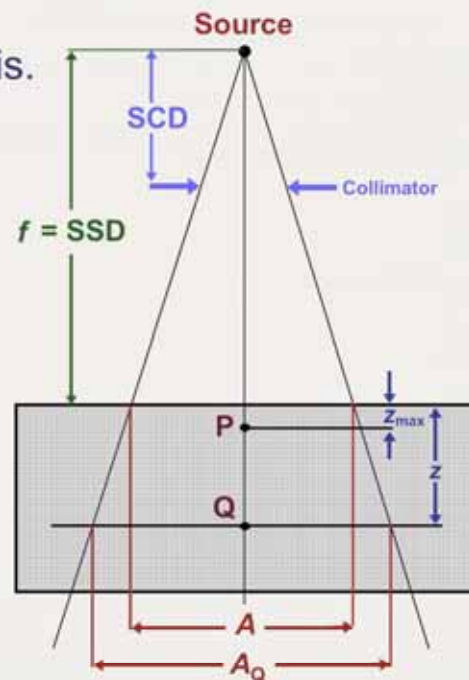

## 6.6 RADIATION TREATMENT PARAMETERS

- ❑ Several functions are in use for linking the dose at a reference point in a water phantom to the dose at arbitrary points inside the patient.
  - Some of these functions can be used in the whole energy range of interest in radiotherapy from superficial through orthovoltage and cobalt-60 to megavoltage
  - Others are only applicable at energies of cobalt-60 and below.
  - Or are used at cobalt-60 energy and above.
- ❑ Cobalt-60 serves as a transition point linking various dosimetry techniques.



## 6.6 RADIATION TREATMENT PARAMETERS

- ❑ **Dosimetric functions used in the whole photon energy range:**
  - Percentage depth dose (PDD)
  - Relative dose factor (RDF)
- ❑ **Dosimetric functions used at cobalt-60 and below:**
  - Peak scatter factor (PSF)
  - Collimator factor (CF)
  - Scatter factor (SF)
  - Scatter function (S)
  - Tissue air ratio (TAR)
  - Scatter air ratio (SAR)
- ❑ **Dosimetric functions used at cobalt-60 and above:**
  - Tissue maximum ratio (TMR)
  - Tissue phantom ratio (TPR)
  - Scatter maximum ratio (SMR)



## 6.6 RADIATION TREATMENT PARAMETERS

### 6.6.1 Radiation beam field size

- ❑ Four general groups of field shape are used in radiotherapy
  - **Square** (produced with collimators installed in therapy machine)
  - **Rectangular** (produced with collimators installed in therapy machine)
  - **Circular** (produced with special collimators attached to treatment machine)
  - **Irregular** (produced with custom made shielding blocks or with multileaf collimators)
- ❑ For any arbitrary radiation field and **equivalent square field** or **equivalent circular field** may be found. The equivalent field will be characterized with similar beam parameters and functions as the arbitrary radiation field.



## 6.6 RADIATION TREATMENT PARAMETERS

### 6.6.1 Radiation beam field size

□ Radiation fields are divided into two categories: geometric and dosimetric (physical).

- According to the ICRU, the **geometric field size** is defined as “the projection of the distal end of the machine collimator onto a plane perpendicular to the central axis of the radiation beam as seen from the front center of the source.”
- The **dosimetric field size** (also called the **physical field size**) is defined by the intercept of a given isodose surface (usually 50% but can also be up to 80%) with a plane perpendicular to the central axis of the radiation beam at a defined distance from the source.



## 6.6 RADIATION TREATMENT PARAMETERS

### 6.6.1 Radiation beam field size

□ Equivalent square for rectangular field:

- An arbitrary rectangular field with sides  $a$  and  $b$  will be approximately equal to a square field with side  $a_{\text{eq}}$  when **both fields have the same area/perimeter ratio** (Day's rule).

$$\frac{ab}{2(a+b)} = \frac{a_{\text{eq}}^2}{4a_{\text{eq}}}$$

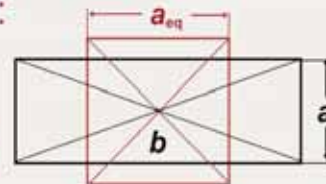

$$a_{\text{eq}} = \frac{2ab}{a+b}$$

□ Equivalent circle for square field:

- An arbitrary square field with side  $a$  will be equivalent to a circular field with radius  $r_{\text{eq}}$  when **both fields have the same area**.

$$a^2 = \pi r_{\text{eq}}^2$$

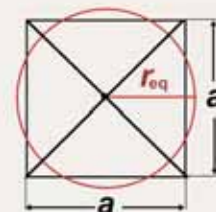

$$r_{\text{eq}} = \frac{a}{\sqrt{\pi}}$$



## 6.6 RADIATION TREATMENT PARAMETERS

### 6.6.2 Collimator factor

□ Exposure in air  $X_{\text{air}}$ , air kerma in air  $(K_{\text{air}})_{\text{air}}$  and dose to small mass of medium in air  $D'_{\text{med}}$  contain two components:

- **Primary component** is the major component.  
It originates in the source, comes directly from the source, and does not depend on field size.
- **Scatter component** is a minor, yet non-negligible, component.  
It represents the scatter from the collimator, air and flattening filter (in linacs) and depends on the field size  $A$ .



## 6.6 RADIATION TREATMENT PARAMETERS

### 6.6.2 Collimator factor

□  $X_{\text{air}}$ ,  $(K_{\text{air}})_{\text{air}}$  and  $D'_{\text{med}}$  depend upon:

- Field size  $A$
- Parameter called the **collimator factor (CF)**  
or  
collimator scatter factor  $S_c$   
or  
relative exposure factor (REF).



## 6.6 RADIATION TREATMENT PARAMETERS

### 6.6.2 Collimator factor

□ Collimator factor is defined as:

$$CF(A, h\nu) = S_c(A, h\nu) = REF(A, h\nu) = \frac{X(A, h\nu)}{X(10, h\nu)} = \frac{(K_{air}(A, h\nu))_{air}}{(K_{air}(10, h\nu))_{air}} = \frac{D'(A, h\nu)}{D'(10, h\nu)}$$

- CF is normalized to 1 for the nominal field of 10x10 cm<sup>2</sup> at the nominal SSD for the treatment machine.
- CF > 1 for fields A exceeding 10x10 cm<sup>2</sup>.
- CF = 1 for 10x10 cm<sup>2</sup> field.
- CF < 1 for fields A smaller than 10x10 cm<sup>2</sup>.

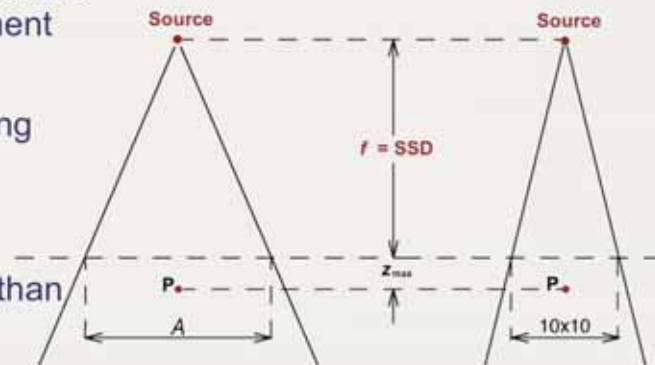

## 6.6 RADIATION TREATMENT PARAMETERS

### 6.6.3 Peak scatter factor

□ Dose to small mass of medium  $D'_p$  at point P is related to dose  $D_p$  at  $z_{max}$  in phantom at point P through the **peak scatter factor PSF**

$$PSF(A, h\nu) = \frac{D_p(z_{max}, A, f, h\nu)}{D'_p(A, h\nu)}$$

- $D'_p$  is measured in air with just enough material around point P to provide electronic equilibrium
- $D_p$  is measured in phantom at point P at depth  $z_{max}$  on central axis.
- Both  $D'_p$  and  $D_p$  are measured with the same field size A defined at a distance  $f = SSD$  from the source.



## 6.6 RADIATION TREATMENT PARAMETERS

### 6.6.3 Peak scatter factor

□ 
$$\text{PSF}(A, hv) = \frac{D_P(z_{\max}, A, f, hv)}{D'_P(A, hv)}$$

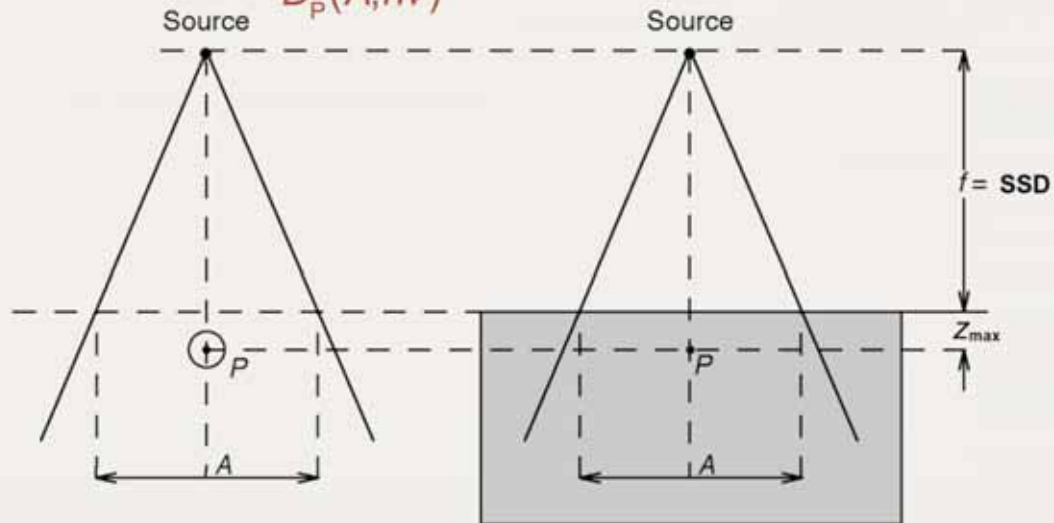

## 6.6 RADIATION TREATMENT PARAMETERS

### 6.6.3 Peak scatter factor

- PSF gives the factor by which the radiation dose at point P in air is increased by **scattered radiation** when point P is in the phantom at depth  $z_{\max}$ .

- PSF depends upon:

- **Field size A**  
(the larger is the field size, the larger is PSF).
- **Photon energy  $hv$**   
(except at very low photon energies, PSF decreases with increasing energy).

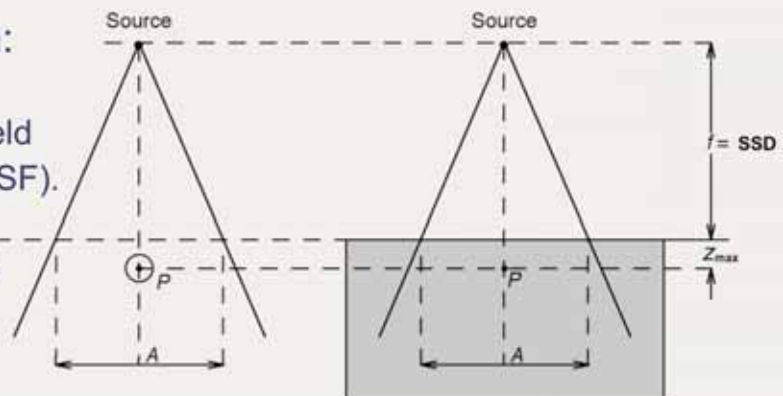



## 6.6 RADIATION TREATMENT PARAMETERS

### 6.6.3 Peak scatter factor

- At low photon energies,  $z_{\max}$  is on the phantom surface ( $z_{\max} = 0$ ) and the peak scatter factor is referred to as the **backscatter factor BSF**.
- PSF for field size of zero area is equal to 1 for all photon beam energies, i.e.,  $PSF(0 \times 0, hv) = 1$
- As the field size increases, PSF first increases from unity linearly as field size increases and then saturates at very large fields.

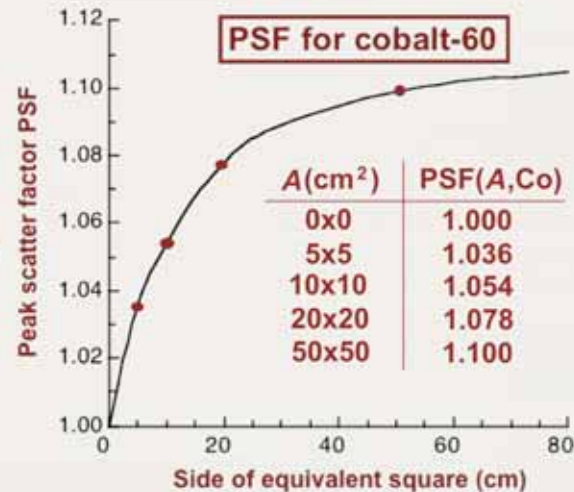

## 6.6 RADIATION TREATMENT PARAMETERS

### 6.6.3 Peak scatter factor

- The interrelationship between the amount of backscattering and the scattered photon penetration causes the PSF:
  - First to increase slowly with beam energy.
  - Then to reach a peak around HVL of 1 mm of copper.
  - Finally to decrease with further increase in beam energy.

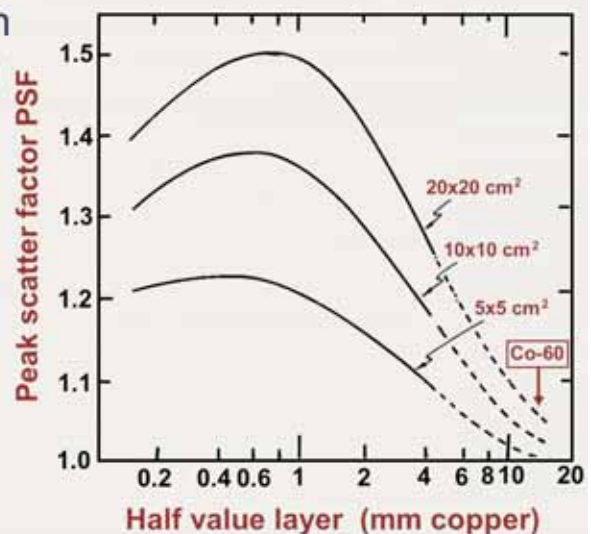



## 6.6 RADIATION TREATMENT PARAMETERS

### 6.6.3 Peak scatter factor

- The beam quality at which the maximum backscatter occurs shifts toward harder radiation with increasing field size.
- Peak scatter factor  $PSF(A, h\nu)$  normalized to read 1.0 for a  $10 \times 10 \text{ cm}^2$  field is referred to as the **relative PSF** or simply the **scatter factor SF** for field A.

$$SF(A, h\nu) = \frac{PSF(A, h\nu)}{PSF(10, h\nu)}$$

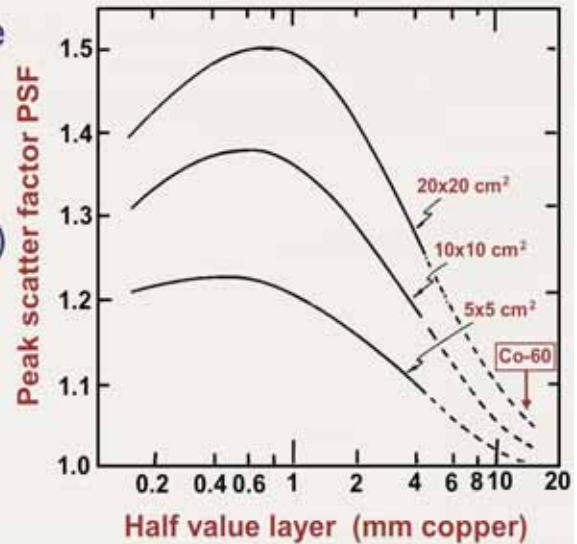

## 6.6 RADIATION TREATMENT PARAMETERS

### 6.6.4 Relative dose factor

- For a given photon beam with energy  $h\nu$  at a given SSD, the dose at point P (at depth  $z_{\max}$ ) depends on field size A; the larger is the field size the larger is the dose.
- The ratio of the dose at point P for field size A to the dose at point P for field size  $10 \times 10 \text{ cm}^2$  is called the **relative dose factor RDF** or **total scatter factor  $S_{c,p}$**  in Khan's notation or machine output factor OF:

$$RDF(A, h\nu) = S_{c,p}(A, h\nu) = \frac{D_P(z_{\max}, A, f, h\nu)}{D_P(z_{\max}, 10, f, h\nu)}$$



## 6.6 RADIATION TREATMENT PARAMETERS

### 6.6.4 Relative dose factor

□ Relative dose factor:  $RDF(A, hv) = S_{c,p}(A, hv) = \frac{D_p(z_{max}, A, f, hv)}{D_p(z_{max}, 10, f, hv)}$

□ For  $A < 10 \times 10 \text{ cm}^2$   
 $RDF(A, hv) < 1$

□ For  $A = 10 \times 10 \text{ cm}^2$   
 $RDF(A, hv) = 1$

□ For  $A > 10 \times 10 \text{ cm}^2$   
 $RDF(A, hv) > 1$

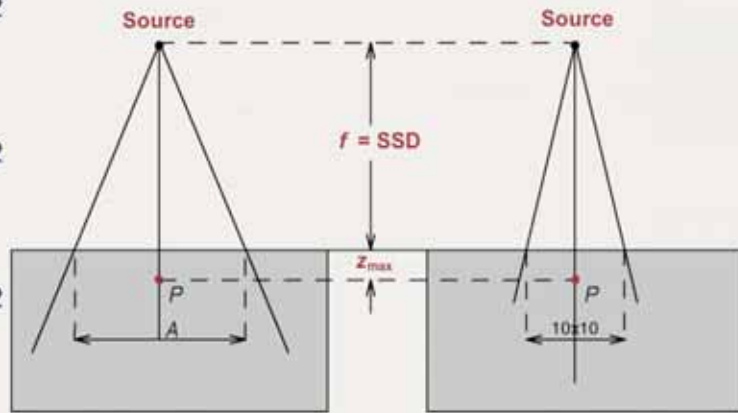

## 6.6 RADIATION TREATMENT PARAMETERS

### 6.6.4 Relative dose factor

□  $RDF(A, hv)$  can be written as a product of

$$CF(A, hv) = \frac{D'_p(A, hv)}{D'_p(10, hv)} \quad \text{and} \quad SF(A, hv) = \frac{PSF(A, hv)}{PSF(10, hv)} :$$

$$\begin{aligned} RDF(A, hv) &= S_{c,p}(A, hv) = \frac{D_p(z_{max}, A, f, hv)}{D_p(z_{max}, 10, f, hv)} = \\ &= \frac{D'_p(A, hv) PSF(A, hv)}{D'_p(10, hv) PSF(10, hv)} = CF(A, hv) SF(A, hv) \end{aligned}$$



## 6.6 RADIATION TREATMENT PARAMETERS

### 6.6.4 Relative dose factor

- Typical values for  $RDF(A, h\nu)$ ,  $CF(A, h\nu)$  and  $SF(A, h\nu)$  for a cobalt-60 gamma ray beam:

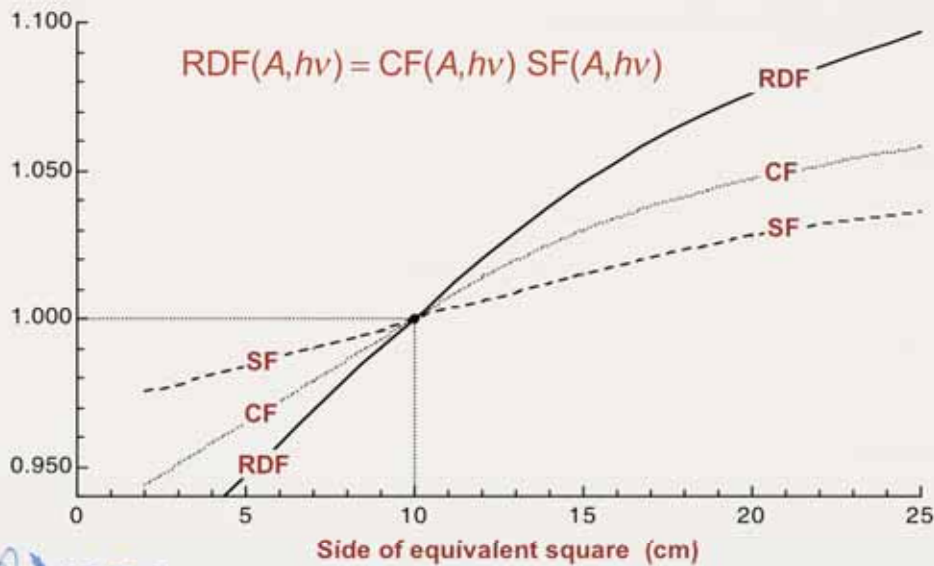

Radiation Oncology Physics: A Handbook for Teachers and Students - 6.6.4 Slide 5

## 6.6 RADIATION TREATMENT PARAMETERS

### 6.6.4 Relative dose factor

- When extra shielding is used on an accessory tray or a multileaf collimator (MLC) is used to shape the radiation field on the patient's surface into an irregular field B, then the  $RDF(B, h\nu)$  is in the first approximation given as:

$$RDF(B, h\nu) = CF(A, h\nu) SF(B, h\nu)$$

- Field A represents the field set by the machine collimator.
- Field B represents the actual irregular field on the patient's surface.



Radiation Oncology Physics: A Handbook for Teachers and Students - 6.6.4 Slide 6

## 6.7 CENTRAL AXIS DEPTH DOSES IN WATER: SSD SETUP

### 6.7.1 Percentage depth dose

- Central axis dose distributions inside the patient are usually normalized to  $D_{\max} = 100\%$  at the depth of dose maximum  $z_{\max}$  and then referred to as **percentage depth dose (PDD)** distributions.
- PDD is thus defined as follows:

$$\text{PDD}(z, A, f, h\nu) = 100 \frac{D_Q}{D_P} = \frac{\dot{D}_Q}{\dot{D}_P}$$

- $D_Q$  and  $\dot{D}_Q$  are the dose and dose rate, respectively, at arbitrary point Q at depth  $z$  on the beam central axis.
- $D_P$  and  $\dot{D}_P$  are the dose and dose rate, respectively, at reference point P at depth  $z_{\max}$  on the beam central axis.



## 6.7 CENTRAL AXIS DEPTH DOSES IN WATER: SSD SETUP

### 6.7.1 Percentage depth dose

- The **percentage depth dose** depends on four parameters:

- Depth in phantom  $z$
- Field size  $A$  on patient's surface
- Source-surface distance  $f = \text{SSD}$
- Photon beam energy  $h\nu$

$$\text{PDD}(z, A, f, h\nu) = 100 \frac{D_Q}{D_P} = \frac{\dot{D}_Q}{\dot{D}_P}$$

- PDD ranges in value from

- 0 at  $z \rightarrow \infty$
- To 100 at  $z = z_{\max}$

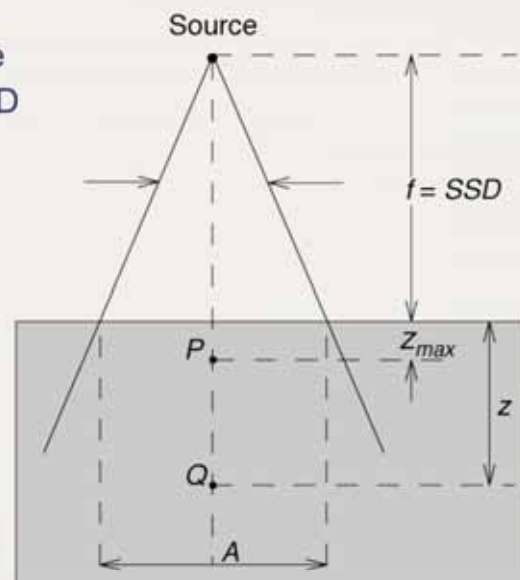

## 6.7 CENTRAL AXIS DEPTH DOSES IN WATER: SSD SETUP

### 6.7.1 Percentage depth dose

- The dose at point Q in the patient consists of two components: primary component and scatter component.

- The **primary component** is expressed as:

$$\text{PDD}^{\text{pri}} = 100 \frac{D_{\text{Q}}^{\text{pri}}}{D_{\text{p}}^{\text{pri}}} = 100 \left( \frac{f + z_{\text{max}}}{f + z} \right)^2 e^{-\mu_{\text{eff}}(z - z_{\text{max}})}$$

$\mu_{\text{eff}}$  is the effective linear attenuation coefficient for the primary beam in the phantom material (for example,  $\mu_{\text{eff}}$  for a cobalt-60 beam in water is  $0.0657 \text{ cm}^{-1}$ ).



## 6.7 CENTRAL AXIS DEPTH DOSES IN WATER: SSD SETUP

### 6.7.1 Percentage depth dose

- The dose at point Q in the patient consists of two components: primary component and scatter component.

- The **scatter component at point Q** reflects the relative contribution of the scattered radiation to the dose at point Q. It depends in a complicated fashion on various parameters such as depth, field size and source-skin distance.
- Contrary to the primary component in which the photon contribution to the dose at point Q arrives directly from the source, the scatter dose is delivered by photons produced through Compton scattering in the patient, machine collimator, flattening filter or air.



## 6.7 CENTRAL AXIS DEPTH DOSES IN WATER: SSD SETUP

### 6.7.1 Percentage depth dose

- For a constant  $A$ ,  $f$ , and  $h\nu$ ,  $PDD(z, A, f, h\nu)$  first increases from the surface to  $z = z_{\max}$  (buildup region), and then decreases with  $z$ .

- Example:

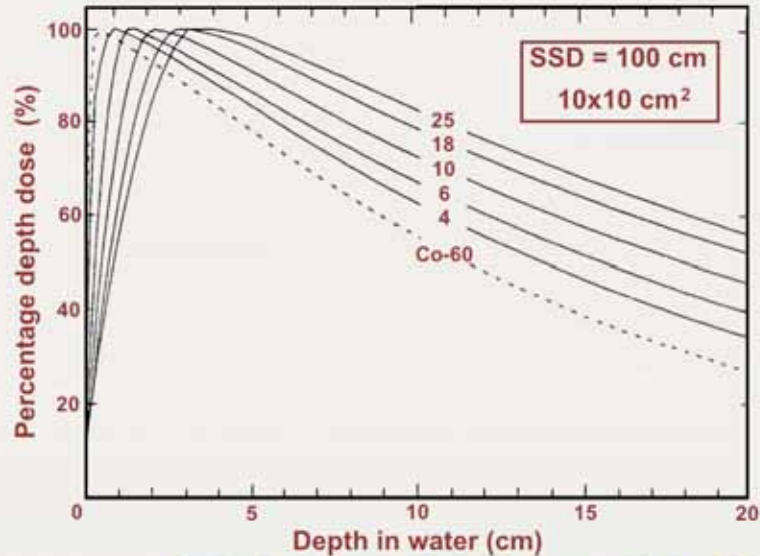

Radiation Oncology Physics: A Handbook for Teachers and Students - 6.7.1 Slide 5

## 6.7 CENTRAL AXIS DEPTH DOSES IN WATER: SSD SETUP

### 6.7.1 Percentage depth dose

- For a constant  $z$ ,  $f$ , and  $h\nu$ ,  $PDD(z, A, f, h\nu)$  increases with increasing field size  $A$  because of increased scatter contribution to points on the central axis.

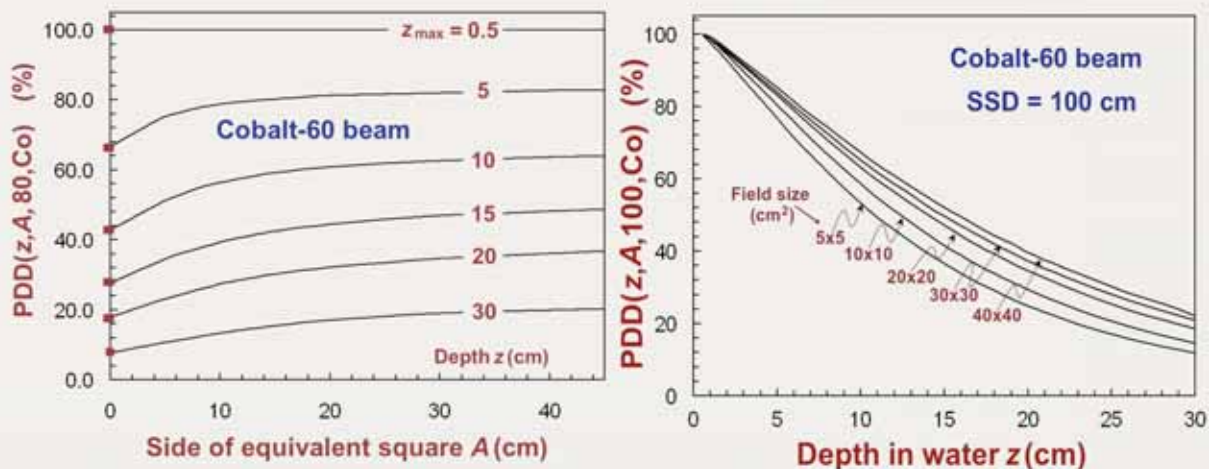

Radiation Oncology Physics: A Handbook for Teachers and Students - 6.7.1 Slide 6



## 6.7 CENTRAL AXIS DEPTH DOSES IN WATER: SSD SETUP

### 6.7.1 Percentage depth dose

- Dependence of high energy photon beams on field size

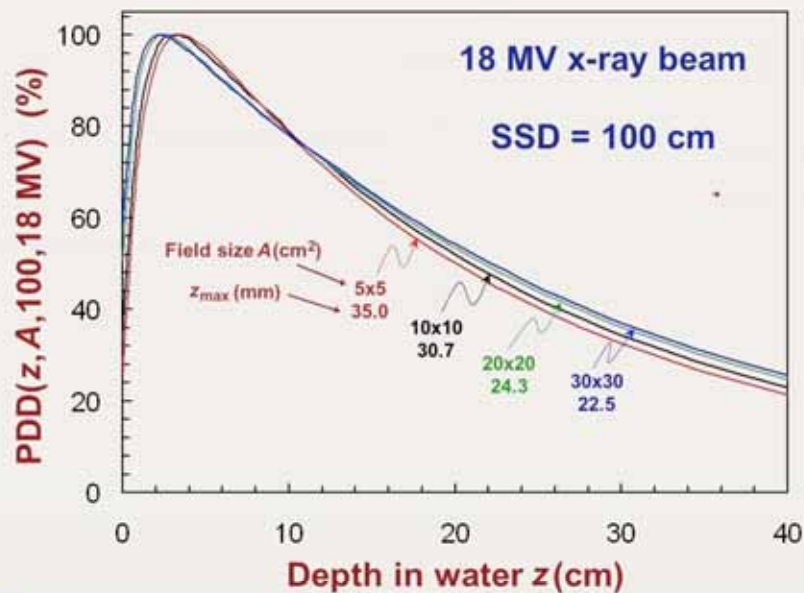

Radiation Oncology Physics: A Handbook for Teachers and Students - 6.7.1 Slide 7

## 6.7 CENTRAL AXIS DEPTH DOSES IN WATER: SSD SETUP

### 6.7.1 Percentage depth dose

- In high energy photon beams, the depth of dose maximum  $z_{\max}$  also depends on field size A:

- For a given beam energy the maximum  $z_{\max}$  occurs for 5x5 cm<sup>2</sup>.
- For fields smaller than 5x5 cm<sup>2</sup> the in-phantom scatter affects  $z_{\max}$ ; the smaller is the field A, the shallower is  $z_{\max}$ .
- For fields larger than 5x5 cm<sup>2</sup> scatter from collimator and flattening filter affect  $z_{\max}$ ; the larger is the field A, the shallower is  $z_{\max}$ .

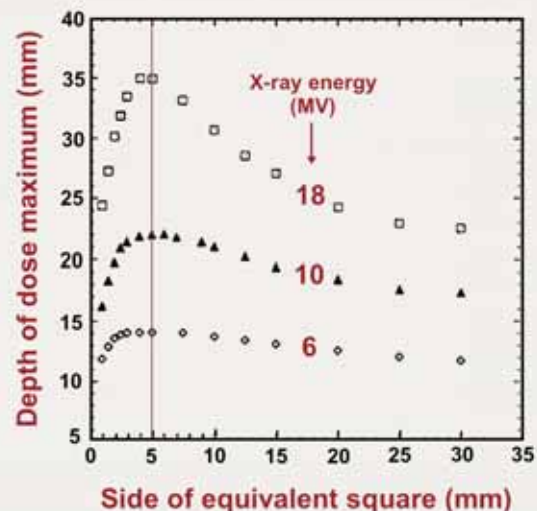

Radiation Oncology Physics: A Handbook for Teachers and Students - 6.7.1 Slide 8

## 6.7 CENTRAL AXIS DEPTH DOSES IN WATER: SSD SETUP

### 6.7.1 Percentage depth dose

- For a constant  $z$ ,  $A$ , and  $h\nu$ ,  $PDD(z, A, f, h\nu)$  increases with increasing  $f$  because of a decreasing effect of depth  $z$  on the inverse square factor, which governs the primary component of the photon beam.

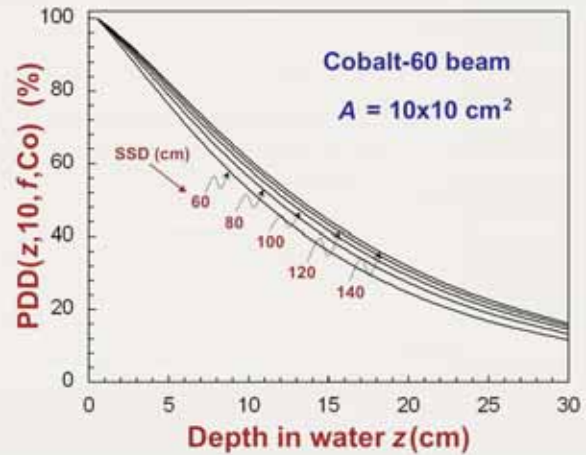
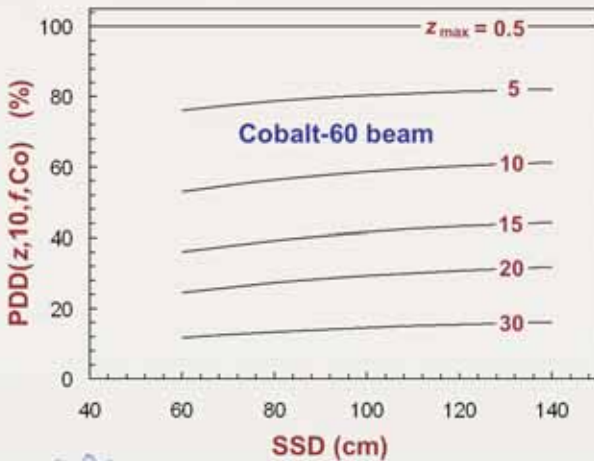

Radiation Oncology Physics: A Handbook for Teachers and Students - 6.7.1 Slide 9

## 6.7 CENTRAL AXIS DEPTH DOSES IN WATER: SSD SETUP

### 6.7.1 Percentage depth dose

- For a constant  $z$ ,  $A$ , and  $f$ ,  $PDD(z, A, f, h\nu)$  beyond  $z_{max}$  increases with beam energy  $h\nu$  because of a decrease in beam attenuation, i.e., increase in beam penetrating power.

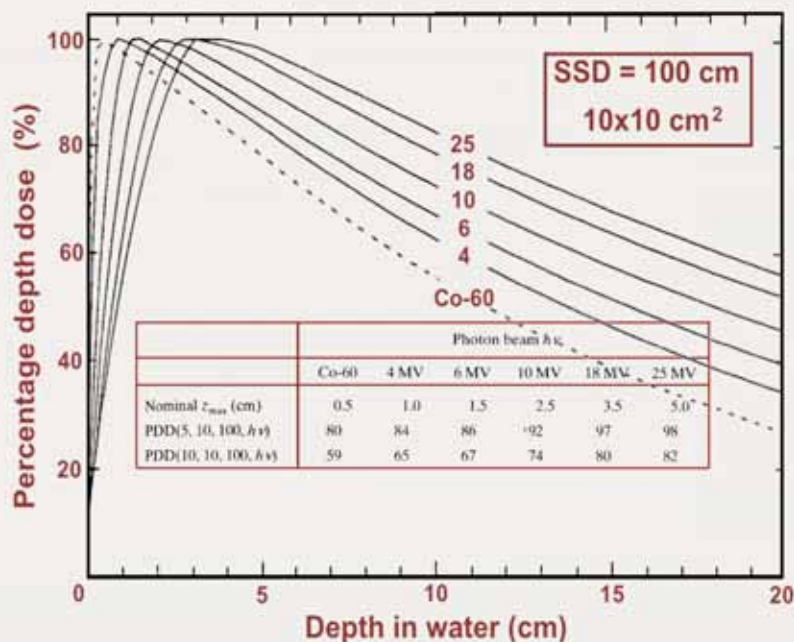

Radiation Oncology Physics: A Handbook for Teachers and Students - 6.7.1 Slide 10



## 6.7 CENTRAL AXIS DEPTH DOSES IN WATER: SSD SETUP

### 6.7.1 Percentage depth dose

#### □ Example: Cobalt-60 beam

	0 × 0	5 × 5	10 × 10	15 × 15	20 × 20	25 × 25	50 × 50
PDD(5, A, 100, Co)	68.2	76.7	80.4	82.0	83.0	83.4	85.2
PDD(10, A, 100, Co)	44.7	53.3	58.7	61.6	63.3	64.4	67.3
PDD(15, A, 100, Co)	29.5	36.5	41.6	44.9	47.1	48.6	49.7

$f = \text{SSD (cm)}$	60	80	100	120	140
PDD(5, 10, $f$ , Co)	76.2	78.8	80.0	81.3	82.3



## 6.7 CENTRAL AXIS DEPTH DOSES IN WATER: SSD SETUP

### 6.7.2 Scatter function

#### □ The scatter component at point Q is determined as follows:

Scatter component at Q = Total dose at Q – Primary dose at Q =

$$= D'_p \text{PSF}(A, hv) \frac{\text{PDD}(z, A, f, hv)}{100} - D'_p \text{PSF}(0, hv) \frac{\text{PDD}(z, 0, f, hv)}{100}$$

#### □ The scatter component depends on four parameters:

- Depth in phantom  $z$
- Field size  $A$
- Source-surface distance  $f$
- Photon beam energy  $hv$



## 6.7 CENTRAL AXIS DEPTH DOSES IN WATER: SSD SETUP

### 6.7.2 Scatter function

- The scatter function  $S(z,A,f,h\nu)$  is defined as the scatter component at point Q normalized to 100 cGy of primary dose at point P:

$$S(z,A,f,h\nu) = \frac{\text{Scatter component at Q}}{D'_p (= 100 \text{ cGy})} =$$

$$= \text{PSF}(A,h\nu) \text{PDD}(z,A,f,h\nu) - \text{PSF}(0,h\nu) \text{PDD}(z,0,f,h\nu)$$

- Note:  $\text{PSF}(0,h\nu) = 1.0$

$$\text{PDD}(z,0,f,h\nu) = 100 \left( \frac{f + z_{\max}}{f + z} \right)^2 e^{-\mu_{\text{ab}}(z - z_{\max})}$$



## 6.7 CENTRAL AXIS DEPTH DOSES IN WATER: SSD SETUP

### 6.7.2 Scatter function

$$S(z,A,f,h\nu) = \frac{\text{Scatter component at Q}}{D'_p (= 100 \text{ cGy})} =$$

$$= \text{PSF}(A,h\nu) \text{PDD}(z,A,f,h\nu) - \text{PSF}(0,h\nu) \text{PDD}(z,0,f,h\nu)$$

$$\text{PDD}(z,0,f,h\nu) =$$

$$= 100 \left( \frac{f + z_{\max}}{f + z} \right)^2 e^{-\mu_{\text{ab}}(z - z_{\max})}$$

At  $z = z_{\max}$  the scatter function  $S$  is given as:

$$S(z_{\max},A,f,h\nu) =$$

$$= 100 \{ \text{PSF}(A,h\nu) - 1 \}$$

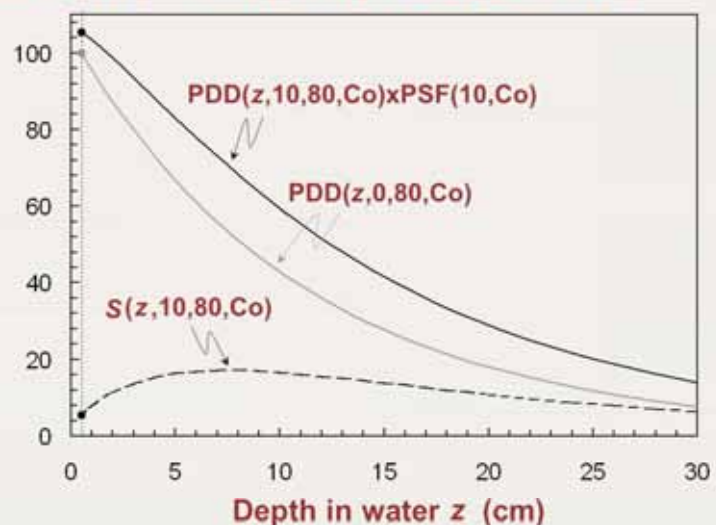

## 6.7 CENTRAL AXIS DEPTH DOSES IN WATER: SSD SETUP

### 6.7.2 Scatter function

- For constant  $A$ ,  $f$ , and  $h\nu$  the scatter function  $S$  first increases with  $z$ , reaches a peak and then slowly decreases with a further increase in  $z$ .
- The larger is the field size, the deeper is the depth of the peak and the larger is scatter function.

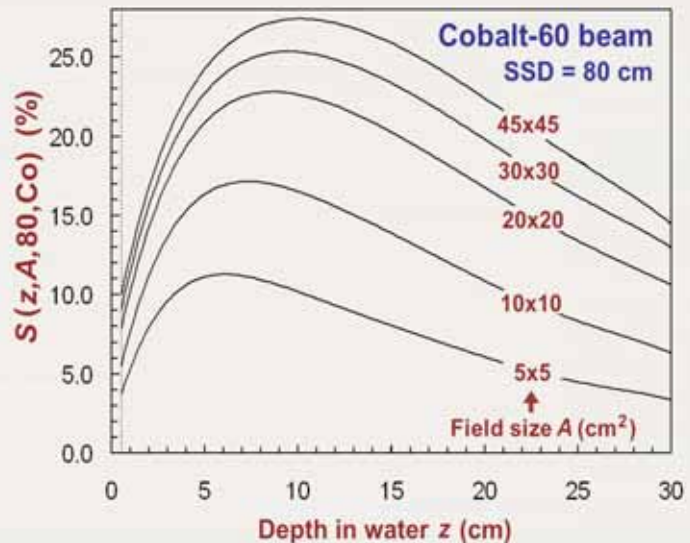

## 6.7 CENTRAL AXIS DEPTH DOSES IN WATER: SSD SETUP

### 6.7.2 Scatter function

- For a constant  $z$ ,  $f$ , and  $h\nu$  the scatter function  $S$  increases with field size  $A$ .
- At large field sizes the scatter function  $S$  saturates.

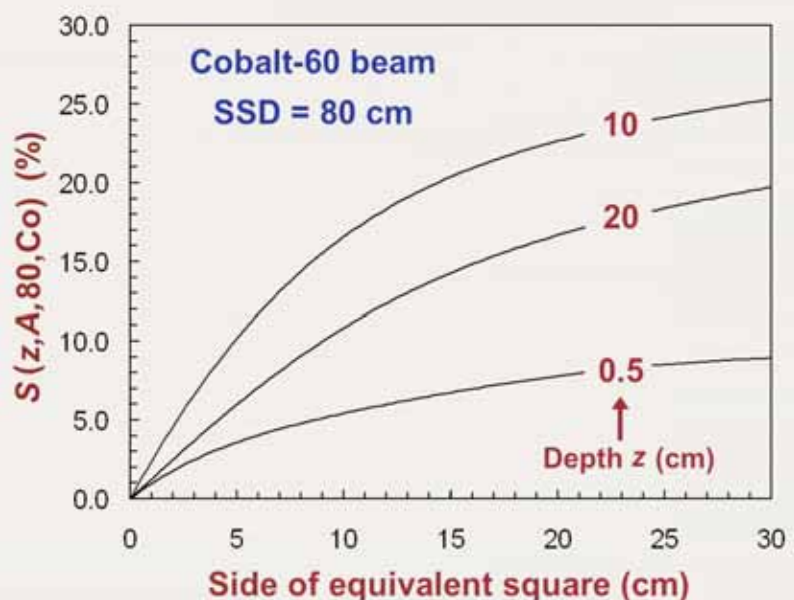

## 6.7 CENTRAL AXIS DEPTH DOSES IN WATER: SSD SETUP

### 6.7.2 Scatter function

- The dose at a given depth in phantom has two components: **primary** and **scatter**.
- The larger is the depth in phantom, the smaller is the relative primary component and the larger is the relative scatter component.

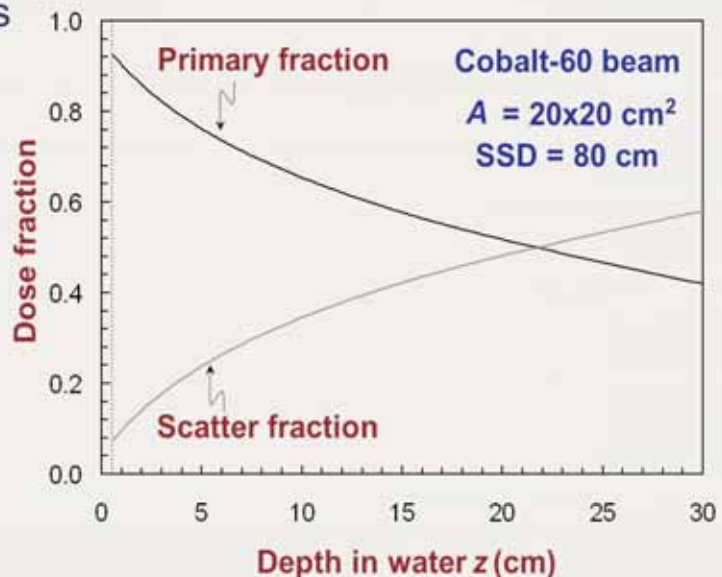

## 6.7 CENTRAL AXIS DEPTH DOSES IN WATER: SSD SETUP

### 6.7.2 Scatter function

- Dependence of scatter function  $S$  on SSD.
- For a constant  $z$ ,  $A$ , and  $h\nu$ , the scatter function  $S$  increases with SSD.

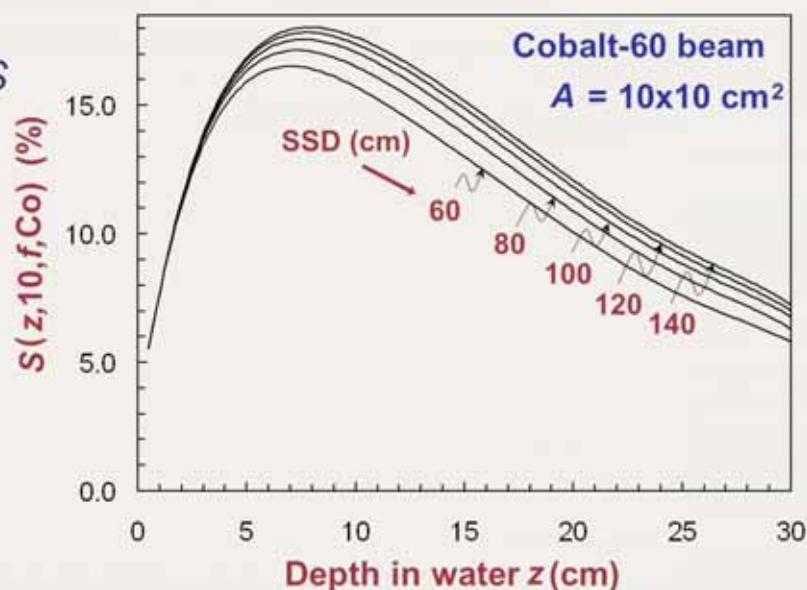

## 6.8 CENTRAL AXIS DEPTH DOSES IN WATER: SAD SETUP

- ❑ SAD setups are used in treatment of deep seated tumours with multiple beams or with rotational beams.
- ❑ In comparison with constant SSD setup that relies on PDD distributions, the SAD setup is more practical and relies on other dose functions such as:
  - Tissue-air ratio (TAR)
  - Tissue-phantom ration (TPR)
  - Tissue-maximum ratio (TMR)



## 6.8 CENTRAL AXIS DEPTH DOSES IN WATER: SAD SETUP

### 6.8.1 Tissue-air ratio

- ❑ Tissue-air ratio (TAR) was introduced by Johns to simplify dose calculations in rotational radiotherapy but is now also used for treatment with multiple stationary beams.
- ❑ The SSD varies from one beam to another; however, the source-axis distance SAD remains constant.

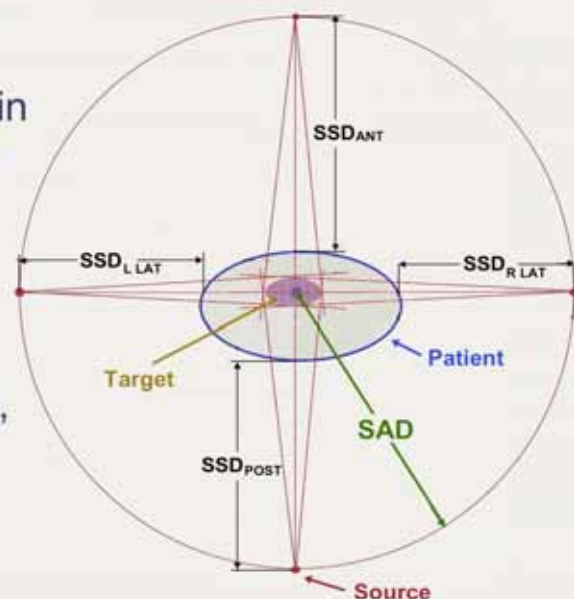

## 6.8 CENTRAL AXIS DEPTH DOSES IN WATER: SAD SETUP

### 6.8.1 Tissue-air ratio

- In contrast to PDD ( $z, A, f, hv$ ) which depends on four parameters, TAR depends on three beam parameters:
  - Depth of isocentre  $z$
  - Field size at isocentre  $A_Q$
  - Beam energy  $hv$
- TAR ( $z, A_Q, hv$ ) does not depend on the SSD in the SSD range from 50 cm to 150 cm used in radiotherapy.
- The field size  $A_Q$  is defined at point Q which is normally placed into the isocentre of the treatment machine.



## 6.8 CENTRAL AXIS DEPTH DOSES IN WATER: SAD SETUP

### 6.8.1 Tissue-air ratio

- TAR( $z, A_Q, hv$ ) is defined as the ratio:  
of the dose  $D_Q$  at point Q on the central axis in the patient to  
the dose  $D'_Q$  to small mass of water in air at the same point  
Q in air

$$\text{TAR}(z, A_Q, hv) = \frac{D_Q}{D'_Q}$$

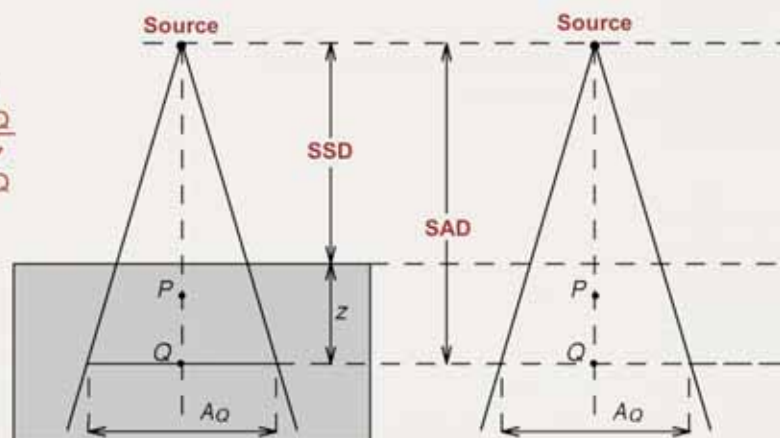



## 6.8 CENTRAL AXIS DEPTH DOSES IN WATER: SAD SETUP

### 6.8.1 Tissue-air ratio

- ❑ Zero area field is a hypothetical radiation field in which the dose at depth  $z$  in phantom is entirely due to primary photons, since the volume that can scatter radiation is zero.

- ❑ Zero area  $TAR(z, A_Q, h\nu)$  is given by a simple exponential function:

$$TAR(z, 0, h\nu) = e^{-\mu_{\text{eff}}(z-z_{\text{max}})}$$

- ❑ For cobalt-60 beam:

- $\mu_{\text{eff}}(\text{Co}) = 0.0657 \text{ cm}^{-1}$
- $TAR(10, 0, \text{Co}) = 0.536$

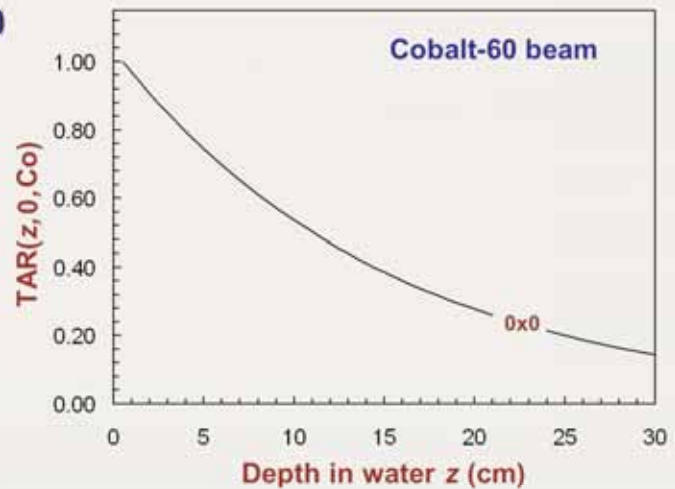

## 6.8 CENTRAL AXIS DEPTH DOSES IN WATER: SAD SETUP

### 6.8.1 Tissue-air ratio

- ❑ The concept of “dose to small mass of medium” is not recommended for beam energies above cobalt-60.
- ❑ Consequently, the concept of TAR is not used for beam energies above cobalt-60 gamma rays.
- ❑ TARs are most reliably measured with ionization chambers; however, the measurements are much more cumbersome than those of PDD because in TAR measurement the source-chamber distance must be kept constant.



## 6.8 CENTRAL AXIS DEPTH DOSES IN WATER: SAD SETUP

### 6.8.1 Tissue-air ratio

- For a constant  $A_Q$  and  $h\nu$ , the TAR decreases with an increasing  $z$  beyond  $z_{\max}$ .

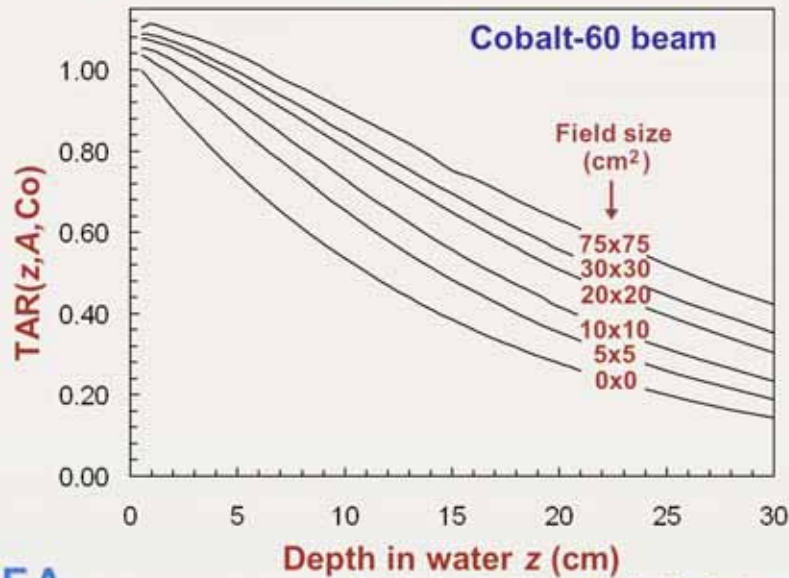

Radiation Oncology Physics: A Handbook for Teachers and Students - 6.8.1 Slide 6

## 6.8 CENTRAL AXIS DEPTH DOSES IN WATER: SAD SETUP

### 6.8.1 Tissue-air ratio

- For a constant  $z$  and  $h\nu$ , the TAR increases with an increasing field size  $A_Q$ .

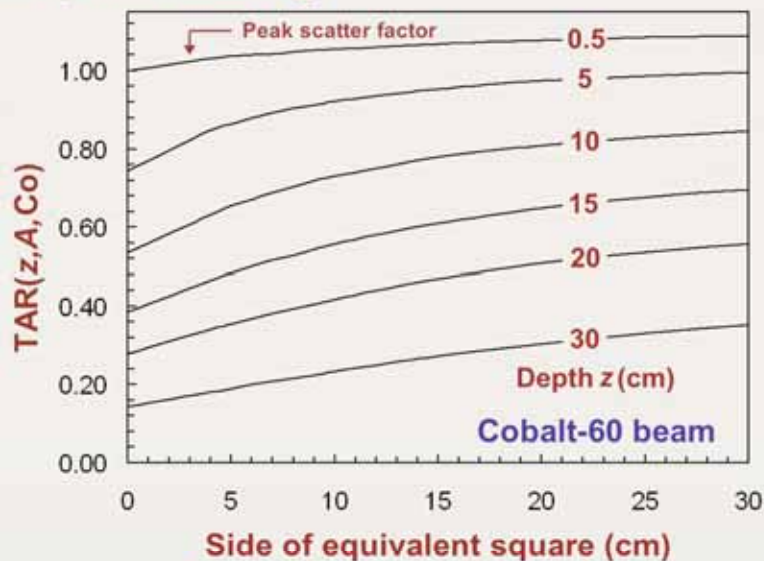

Radiation Oncology Physics: A Handbook for Teachers and Students - 6.8.1 Slide 7



## 6.8 CENTRAL AXIS DEPTH DOSES IN WATER: SAD SETUP

### 6.8.1 Tissue-air ratio

- ❑ The concept of “dose to small mass of medium” is not recommended for beam energies above cobalt-60.
- ❑ Consequently, the concept of TAR is not used for beam energies above cobalt-60 gamma rays.
- ❑ TARs are most reliably measured with ionization chambers; however, the measurements are much more cumbersome than those of PDD because in TAR measurement the source-chamber distance must be kept constant.



## 6.8 CENTRAL AXIS DEPTH DOSES IN WATER: SAD SETUP

### 6.8.2 Relationship between TAR and PDD

- ❑ Basic definitions:

- $PDD(z, A, f, h\nu) = 100 \frac{D_Q}{D_P}$

- $TAR(z, A_Q, h\nu) = \frac{D_Q}{D'_P}$

$$D_Q = D_P \frac{PDD(z, A, f, h\nu)}{100} = D'_Q TAR(z, A_Q, h\nu)$$

$$D_P = D'_P PSF(A, h\nu) = D'_Q \left( \frac{f+z}{f+z_{max}} \right)^2 PSF(A, h\nu)$$

- ❑  $TAR(z, A_Q, h\nu) = PSF(A, h\nu) \frac{PDD(z, A, f, h\nu)}{100} \left( \frac{f+z}{f+z_{max}} \right)^2$

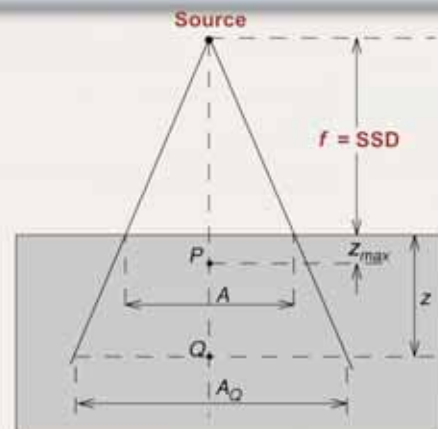

## 6.8 CENTRAL AXIS DEPTH DOSES IN WATER: SAD SETUP

### 6.8.2 Relationship between TAR and PDD

$$\square \quad \text{TAR}(z, A_Q, h\nu) = \text{PSF}(A, h\nu) \frac{\text{PDD}(z, A, f, h\nu)}{100} \left( \frac{f + z}{f + z_{\max}} \right)^2$$

$\square$  Special case at  $z = z_{\max}$  gives  $\text{PDD}(z_{\max}, A, f, h\nu) = 100$

$$\text{TAR}(z_{\max}, A_P, h\nu) \approx \text{PSF}(A, h\nu)$$

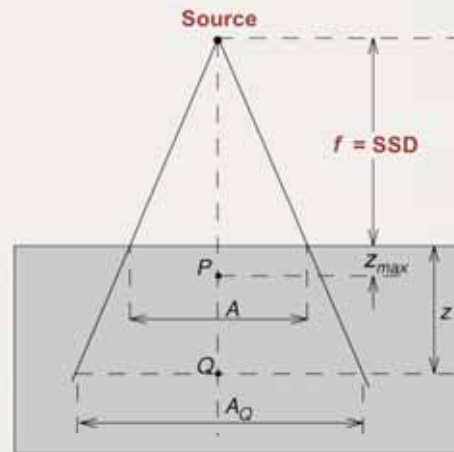

## 6.8 CENTRAL AXIS DEPTH DOSES IN WATER: SAD SETUP

### 6.8.2 Relationship between TAR and PDD

$$\square \quad \text{TAR}(z, A_Q, h\nu) = \text{PSF}(A, h\nu) \frac{\text{PDD}(z, A, f, h\nu)}{100} \left( \frac{f + z}{f + z_{\max}} \right)^2$$

$\square$  Since the TAR does not depend on SSD, a single TAR table for a given photon beam energy may be used to cover all possible SSDs used clinically.

$\square$  Alternatively, PDDs for any arbitrary combination of  $z$ ,  $A$  and  $f = \text{SSD}$  may be calculated from a single TAR table.



## 6.8 CENTRAL AXIS DEPTH DOSES IN WATER: SAD SETUP

### 6.8.2 Relationship between TAR and PDD

- TAR versus PDD relationship:

$$\text{TAR}(z, A_Q, h\nu) = \text{PSF}(A, h\nu) \frac{\text{PDD}(z, A, f, h\nu)}{100} \left( \frac{f+z}{f+z_{\max}} \right)^2$$

- PDD versus TAR relationship:

$$\text{PDD}(z, A, f, h\nu) = 100 \frac{\text{TAR}(z, A_Q, h\nu)}{\text{PSF}(A, h\nu)} \left( \frac{f+z_{\max}}{f+z} \right)^2$$



## 6.8 CENTRAL AXIS DEPTH DOSES IN WATER: SAD SETUP

### 6.8.2 Relationship between TAR and PDD

- PDDs at two different SSDs ( $\text{SSD}_1 = f_1$ ;  $\text{SSD}_2 = f_2$ ):  
Identical field size  $A$  at the two SSDs (on phantom surface):

$$\frac{\text{PDD}(z, A, f_1, h\nu)}{\text{PDD}(z, A, f_2, h\nu)} =$$

$$= \left\{ \frac{\text{TAR}(z, A_{Q_1}, h\nu)}{\text{TAR}(z, A_{Q_2}, h\nu)} \right\} \left\{ \frac{f_1 + z_{\max}}{f_1 + z} \right\}^2 \left\{ \frac{f_2 + z_{\max}}{f_2 + z} \right\}^2$$

Mayneord factor

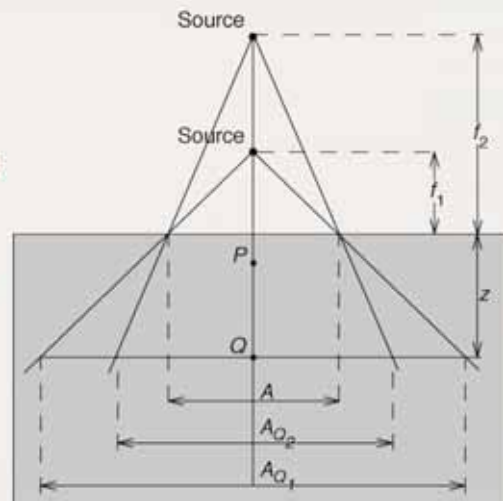

## 6.8 CENTRAL AXIS DEPTH DOSES IN WATER: SAD SETUP

### 6.8.2 Relationship between TAR and PDD

- PDDs at two different SSDs ( $SSD_1 = f_1$ ;  $SSD_2 = f_2$ ):  
Identical field size  $A_Q$  at depth  $z$  in the phantom:

$$\frac{PDD(z, A, f_1, h\nu)}{PDD(z, A, f_2, h\nu)} = \left\{ \frac{PSF(A_2, h\nu)}{PSF(A_1, h\nu)} \right\} \left\{ \frac{f_1 + z_{\max}}{f_1 + z} \cdot \frac{f_2 + z_{\max}}{f_2 + z} \right\}^2$$

Mayneord factor

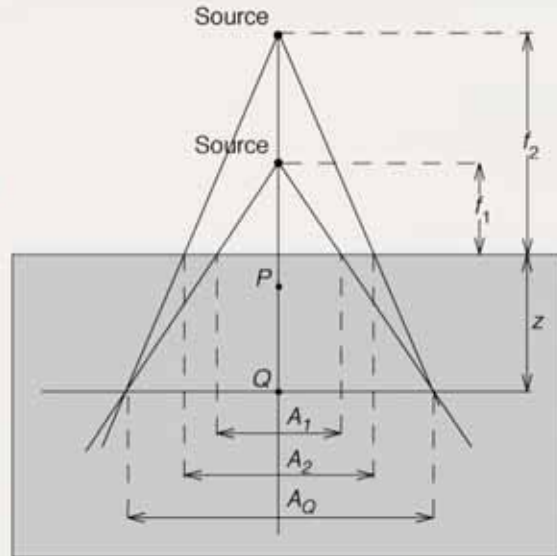

Radiation Oncology Physics: A Handbook for Teachers and Students - 6.8.2 Slide 6



## 6.8 CENTRAL AXIS DEPTH DOSES IN WATER: SAD SETUP

### 6.8.3 Scatter-air ratio SAR

- TAR( $z, A_Q, h\nu$ ) consists of two components:
  - Primary component TAR( $z, 0, h\nu$ ) for zero field size
  - Scatter component referred to as scatter-air ratio SAR( $z, A_Q, h\nu$ )

$$SAR(z, A_Q, h\nu) = TAR(z, A_Q, h\nu) - TAR(z, 0, h\nu)$$

- The SAR gives the scatter contribution to the dose at point Q in a water phantom per 1 cGy of dose to a small mass of water at point Q in air.

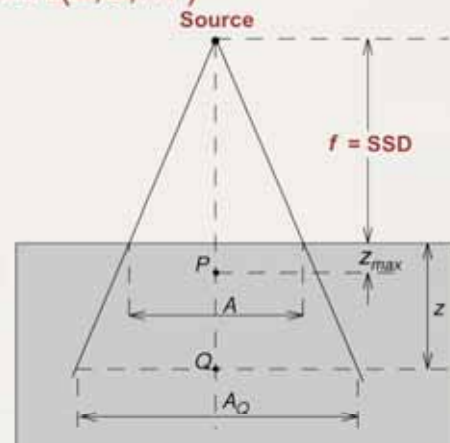

Radiation Oncology Physics: A Handbook for Teachers and Students - 6.8.3 Slide 1



## 6.8 CENTRAL AXIS DEPTH DOSES IN WATER: SAD SETUP

### 6.8.4 Relationship between SAR and scatter function S

- Using the relationships:

$$\text{SAR}(z, A_Q, h\nu) = \text{TAR}(z, A_Q, h\nu) - \text{TAR}(z, 0, h\nu)$$

$$\text{TAR}(z, A_Q, h\nu) = \text{PSF}(A, h\nu) \frac{\text{PDD}(z, A, f, h\nu)}{100} \left( \frac{f + z}{f + z_{\max}} \right)^2$$

$$S(z, A, f, h\nu) = \text{PSF}(A, h\nu) \text{PDD}(z, A, f, h\nu) - \text{PSF}(0, h\nu) \text{PDD}(z, 0, f, h\nu)$$

we obtain the following relationship between SAR and S

$$\text{SAR}(z, A_Q, h\nu) = \frac{S(z, A, f, h\nu)}{100} \left( \frac{f + z}{f + z_{\max}} \right)^2$$

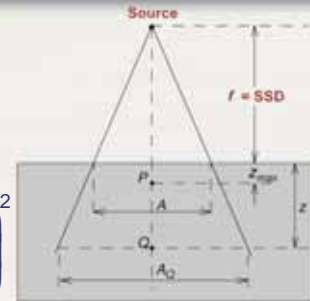

## 6.8 CENTRAL AXIS DEPTH DOSES IN WATER: SAD SETUP

### 6.8.5 Tissue-phantom ratio TPR and Tissue-maximum ratio TMR

- For isocentric setups with megavoltage photon energies the concept of **tissue-phantom ratio TPR** was developed.
- Similarly to TAR the TPR depends upon  $z$ ,  $A_Q$ , and  $h\nu$ .
- TPR is defined as:

$$\text{TPR}(z, A_Q, h\nu) = \frac{D_Q}{D_{Q_{\text{ref}}}}$$

- $D_Q$  is the dose at point Q at depth  $z$
- $D_{Q_{\text{ref}}}$  is the dose at depth  $z_{\text{ref}}$ .

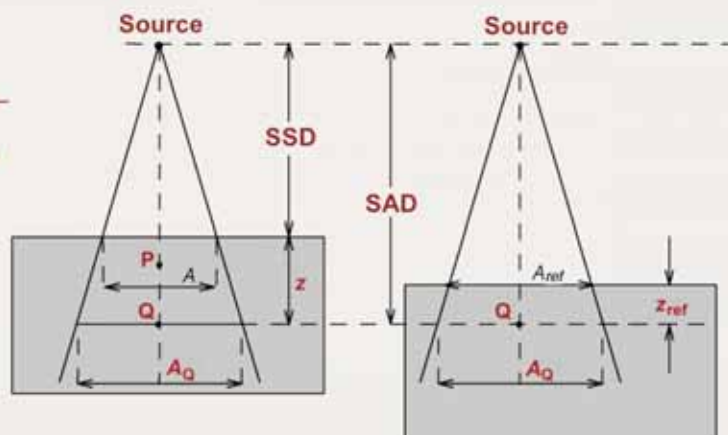

## 6.8 CENTRAL AXIS DEPTH DOSES IN WATER: SAD SETUP

### 6.8.5 Tissue-phantom ratio TPR and Tissue-maximum ratio TMR

- ❑ Tissue-maximum ratio **TMR** is a special TPR for  $z_{\text{ref}} = z_{\text{max}}$ .
- ❑ TMR is defined as:

$$\text{TMR}(z, A_Q, hv) = \frac{D_Q}{D_{Q_{\text{max}}}}$$

- $D_Q$  is the dose at point Q at depth  $z$
- $D_{Q_{\text{max}}}$  is the dose at depth  $z_{\text{max}}$ .

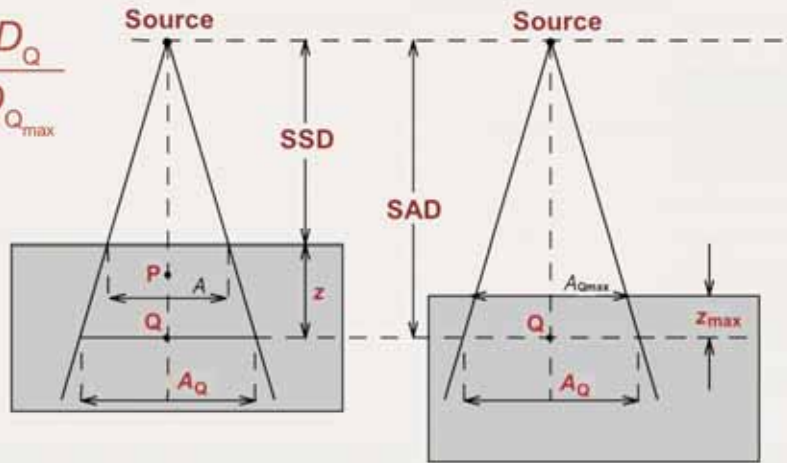

## 6.8 CENTRAL AXIS DEPTH DOSES IN WATER: SAD SETUP

### 6.8.5 Tissue-phantom ratio TPR and Tissue-maximum ratio TMR

- ❑ Just like the TAR, the TPR and TMR depend on three parameters:  $z$ ,  $A_Q$ , and  $hv$  but do not depend on the SAD or SSD.
- ❑ The range of TMR is from 0 for  $z \rightarrow \infty$  to 1 for  $z = z_{\text{max}}$ .
- ❑ For constant  $A_Q$  and  $hv$  the TMR decreases with increasing  $z$ .
- ❑ For constant  $z$  and  $hv$  the TMR increases with increasing  $A_Q$ .
- ❑ For constant  $z$  and  $A_Q$  the TMR increases with increasing  $hv$ .





## 6.8 CENTRAL AXIS DEPTH DOSES IN WATER: SAD SETUP

### 6.8.6 Relationship between TMR and PDD

- A simple relationship between  $TMR(z, A_Q, hv)$  and corresponding  $PDD(z, A, f, hv)$  can be derived from the basic definitions of the two functions:

$$PDD(z, A, f, hv) = 100 \frac{D_Q}{D_P}$$

$$TMR(z, A_Q, hv) = \frac{D_Q}{D_{Q_{max}}}$$

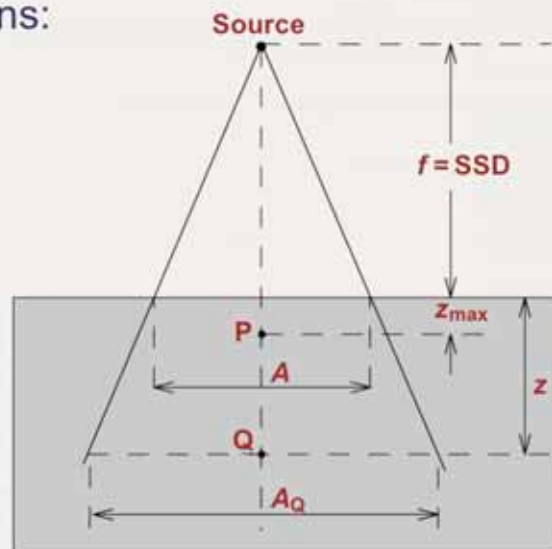

## 6.8 CENTRAL AXIS DEPTH DOSES IN WATER: SAD SETUP

### 6.8.6 Relationship between TMR and PDD

- $D_Q = D_P \frac{PDD(z, A, f, hv)}{100} = D_{Q_{max}} TMR(z, A_Q, hv)$

$$D_P = D'_P \text{PSF}(A, hv) = D'_Q \left( \frac{f + z}{f + z_{max}} \right)^2 \text{PSF}(A, hv)$$

$$D_{Q_{max}} = D'_Q \text{PSF}(A_Q, hv)$$

$$TMR(z, A_Q, hv) = \frac{PDD(z, A, f, hv)}{100} \frac{\text{PSF}(A, hv)}{\text{PSF}(A_Q, hv)} \left( \frac{f + z}{f + z_{max}} \right)^2$$

## 6.8 CENTRAL AXIS DEPTH DOSES IN WATER: SAD SETUP

### 6.8.6 Relationship between TMR and PDD

- General relationship between TMR and PDD

$$\text{TMR}(z, A_Q, h\nu) = \frac{\text{PDD}(z, A, f, h\nu)}{100} \frac{\text{PSF}(A, h\nu)}{\text{PSF}(A_Q, h\nu)} \left( \frac{f+z}{f+z_{\max}} \right)^2$$

- In the first approximation, ignoring the PSF ratio, we get a simpler and practical relationship between TMR and PDD:

$$\text{TMR}(z, A_Q, h\nu) \approx \frac{\text{PDD}(z, A, f, h\nu)}{100} \left( \frac{f+z}{f+z_{\max}} \right)^2$$



## 6.8 CENTRAL AXIS DEPTH DOSES IN WATER: SAD SETUP

### 6.8.7 Scatter-maximum ratio SMR

- $\text{TMR}(z, A_Q, h\nu)$  can be separated into the primary component  $\text{TMR}(z, 0, h\nu)$  and the scatter component called the scatter-maximum ratio  $\text{SMR}(z, A_Q, h\nu)$ .
- $\text{SMR}(z, A_Q, h\nu)$  is essentially  $\text{SAR}(z, A_Q, h\nu)$  for photon energies of cobalt-60 and above.

$$\begin{aligned} \text{SMR}(z, A_Q, h\nu) &= \text{TAR}(z, A_Q, h\nu) - \text{TMR}(z, 0, h\nu) = \\ &= \text{TMR}(z, A_Q, h\nu) \text{PSF}(A_Q, h\nu) - e^{-\mu_{\text{eff}}(z-z_{\max})} \end{aligned}$$

- where  $\mu_{\text{eff}}$  is the effective attenuation coefficient for the megavoltage photon beam energy.



## 6.8 CENTRAL AXIS DEPTH DOSES IN WATER: SAD SETUP

### 6.8.7 Scatter-maximum ratio SMR

$$\begin{aligned} \square \quad \text{SMR}(z, A_Q, hv) &= \text{TAR}(z, A_Q, hv) - \text{TMR}(z, 0, hv) = \\ &= \text{TMR}(z, A_Q, hv) \text{PSF}(A_Q, hv) - e^{-\mu_{\text{eff}}(z - z_{\text{max}})} \end{aligned}$$

- PSF( $A_Q, hv$ ) is very difficult to measure but it can be expressed as:

$$\text{PSF}(A_Q, hv) = \frac{\text{PSF}(A_Q, hv) \text{PSF}(10, hv)}{\text{PSF}(10, hv) \text{PSF}(0, hv)} = \frac{\text{SF}(A_Q, hv)}{\text{SF}(0, hv)}$$

- SMR( $z, A_Q, hv$ ) is then expressed as:

$$\text{SMR}(z, A_Q, hv) = \text{TMR}(z, A_Q, hv) \frac{\text{SF}(A_Q, hv)}{\text{SF}(0, hv)} - \text{TMR}(z, 0, hv)$$



## 6.9 OFF-AXIS RATIOS AND BEAM PROFILES

- Dose distributions along the beam central axis are used in conjunction with **off-axis beam profiles** to deliver an accurate dose description inside the patient.
- The off-axis data are usually given with beam profiles measured perpendicularly to the beam central axis at a given depth in a phantom.
- The depths of measurement are typically at:
- Depths  $z = z_{\text{max}}$  and  $z = 10$  cm for **verification of machine compliance** with machine specifications.
  - **Other depths required by the particular treatment planning system** used in the department.



## 6.9 OFF-AXIS RATIOS AND BEAM PROFILES

- Example of beam profiles measured for two field sizes (10x10 cm<sup>2</sup> and 30x30 cm<sup>2</sup>) of a 10 MV x-ray beam at various depths in water.

- The central axis profile values are scaled by the appropriate PDD value for the two fields.

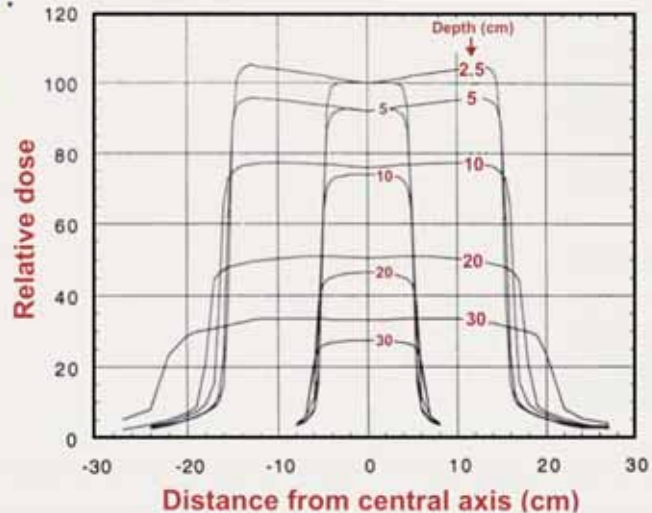

## 6.9 OFF-AXIS RATIOS AND BEAM PROFILES

- Combining a central axis dose distribution with off-axis data results in a volume dose matrix that provides 2-D and 3-D information on the dose distribution in the patient.
- The off-axis ratio OAR is usually defined as the ratio of dose at an off-axis point to the dose on the central beam axis at the same depth in a phantom.



## 6.9 OFF-AXIS RATIOS AND BEAM PROFILES

- Megavoltage beam profiles consist of three regions:
  - **Central region** represents the central portion of the profile extending from the central axis to within 1 to 1.5 cm of the geometric field edges of the beam.
  - **Penumbra** is the region close to geometric field edges where the dose changes rapidly and depends on field defining collimators, the finite size of the focal spot (source size) and the lateral electronic disequilibrium.
  - **Umbra** is the region outside of the radiation field, far removed from the field edges. The dose in this region is low and results from radiation transmitted through the collimator and head shielding.



## 6.9 OFF-AXIS RATIOS AND BEAM PROFILES

- For each of the three beam profile regions there are specific requirements to optimize the clinical photon beam:
  - The **dose profile in the central region** should meet flatness and symmetry specifications.
  - The **dose profile in the penumbral region** should have a rapid falloff with increasing distance from the central axis (narrow penumbra) to optimize beam sharpness at the target edge.
  - The **dose profile in the umbral region** should be close to zero dose to minimize the dose delivered to tissues outside the target volume.



## 6.9 OFF-AXIS RATIOS AND BEAM PROFILES

### □ Ideal dose profile:

- **Central region:** constant dose from target centre to edge of target.
- **Penumbra:** zero width.
- **Umbr:** zero dose.

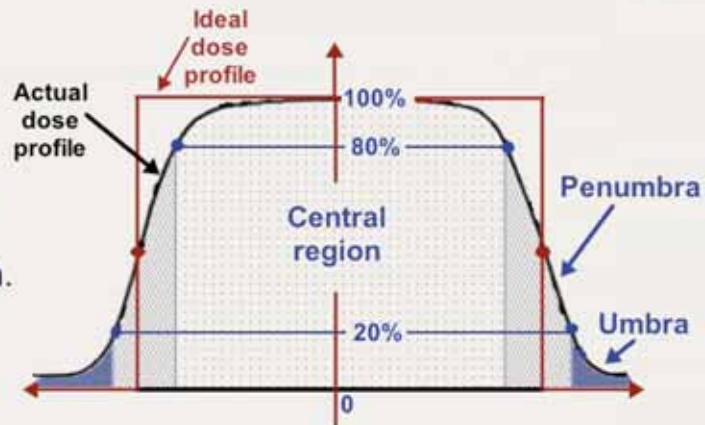

### □ Actual dose profile:

- **Central region:** profile flat in 80% of central portion of the field.
- **Penumbra** is typically defined as the distance between 80% and 20% dose on the beam profile normalized to 100% at the central axis.
- **Umbr** is typically less than 1% of the dose on the central axis.



## 6.9 OFF-AXIS RATIOS AND BEAM PROFILES

### □ Geometric or nominal field size is:

- Indicated by the optical light field of the treatment machine.
- Usually defined as the separation between the 50% dose level points on the beam profile measured at the depth of dose maximum  $z_{max}$ .

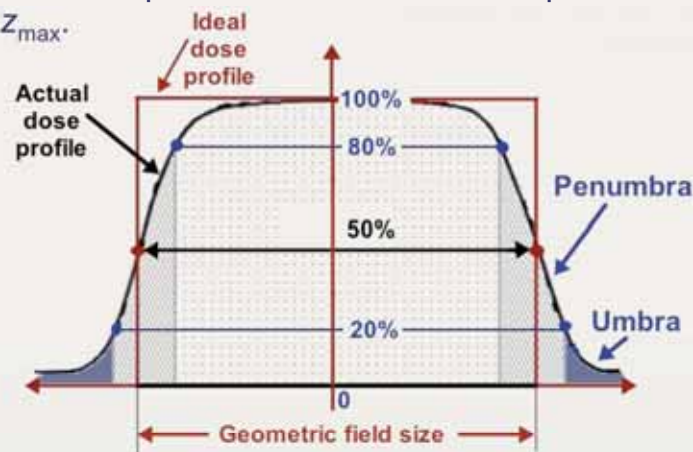



## 6.9 OFF-AXIS RATIOS AND BEAM PROFILES

□ In the central region, the off-axis points of the beam profile are affected:

- For cobalt-60 beams, by the inverse square law dose fall-off and the increased phantom thickness as the off-axis distance increases.
- For linacs, by the energy of electrons striking the target, by the atomic number of the target, and the atomic number and shape of the flattening filter.

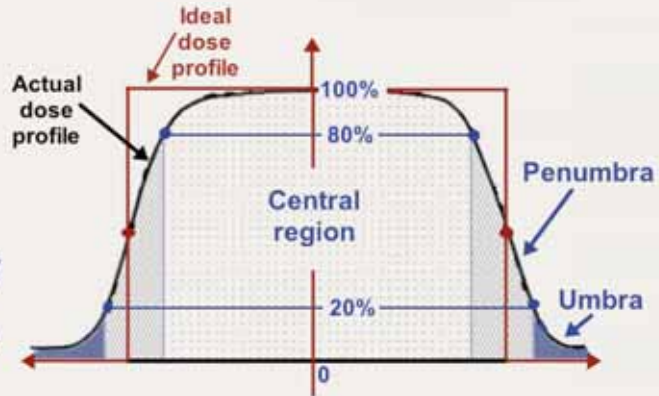

## 6.9 OFF-AXIS RATIOS AND BEAM PROFILES

□ The total penumbra is referred to as the **physical penumbra** and consists of three components:

- **Geometric penumbra** results from the finite source size.
- **Scatter penumbra** results from in-patient photon scatter originating in the open field.
- **Transmission penumbra** results from beam transmitted through the collimation device.

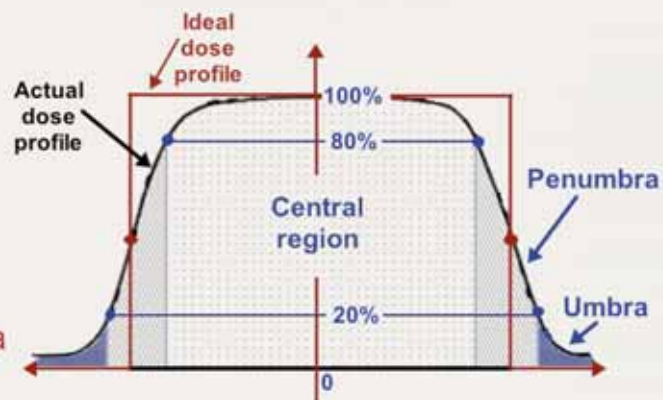

## 6.9 OFF-AXIS RATIOS AND BEAM PROFILES

### 6.9.1 Beam flatness

- Beam flatness  $F$  is assessed by finding the maximum  $D_{\max}$  and minimum  $D_{\min}$  dose point values on the beam profile within the central 80% of the beam width.

- Beam flatness  $F$  is defined as:

$$F = 100 \times \frac{D_{\max} - D_{\min}}{D_{\max} + D_{\min}}$$

- Standard linac specifications require that  $F \leq 3\%$  when measured in a water phantom at a depth  $z = 10$  cm with  $SSD = 100$  cm for the largest field size available (typically  $40 \times 40$  cm<sup>2</sup>).



## 6.9 OFF-AXIS RATIOS AND BEAM PROFILES

### 6.9.1 Beam flatness

- Compliance with the flatness specifications at a depth  $z = 10$  cm in water results in:

- **Over-flattening** at  $z_{\max}$ , manifesting itself in the form of horns in the profile.
- **Under-flattening** at depths exceeding  $z = 10$  cm. This underflattening becomes progressively worse as the depth  $z$  increases beyond  $z = 10$  cm.

- The over-flattening and under-flattening of the beam profiles is caused by the lower beam effective energies in off-axis directions compared with the central axis direction.



## 6.9 OFF-AXIS RATIOS AND BEAM PROFILES

### 6.9.1 Beam flatness

- Typical profiles measured in water with a 40x40 cm<sup>2</sup> field at SSD = 100 cm. The data for depths  $z = 10$  cm and  $z = z_{\max}$  are used for verification of compliance with standard machine specifications.

$$F = 100 \times \frac{D_{\max} - D_{\min}}{D_{\max} + D_{\min}}$$

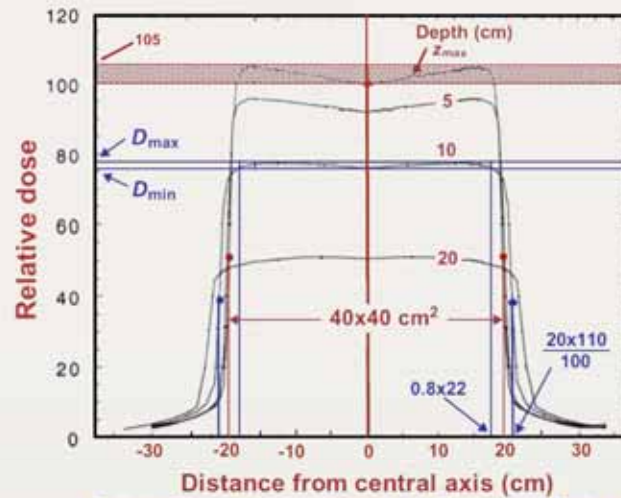

Radiation Oncology Physics: A Handbook for Teachers and Students - 6.9.1 Slide 3

## 6.9 OFF-AXIS RATIOS AND BEAM PROFILES

### 6.9.2 Beam symmetry

- Beam symmetry  $S$  is usually determined at  $z_{\max}$  to achieve maximum sensitivity.
- Typical symmetry specifications for a 40x40 cm<sup>2</sup> field:
  - Any two dose points on a beam profile, equidistant from the central axis point, should be within 2% of each other.
  - Areas under the  $z_{\max}$  beam profile on each side (left and right) of the central axis extending to the 50% dose level (normalized to 100% at the central axis point) are determined.

## 6.9 OFF-AXIS RATIOS AND BEAM PROFILES

### 6.9.2 Beam symmetry

□  $S$  is calculated from

$$S = 100 \times \frac{\text{area}_{\text{left}} - \text{area}_{\text{right}}}{\text{area}_{\text{left}} + \text{area}_{\text{right}}}$$

and should be less than 2%.

□ Practical options for determination of areas under the profile curve with a hard copy of the profile are:

- using a planimeter
- OR
- counting squares on graph paper.



## 6.9 OFF-AXIS RATIOS AND BEAM PROFILES

### 6.9.2 Beam symmetry

□ The areas under the  $Z_{\text{max}}$  profile can often be determined using an automatic **software option** on the water tank scanning device (3-D isodose plotter).

$$S = 100 \times \frac{\text{area}_{\text{left}} - \text{area}_{\text{right}}}{\text{area}_{\text{left}} + \text{area}_{\text{right}}}$$

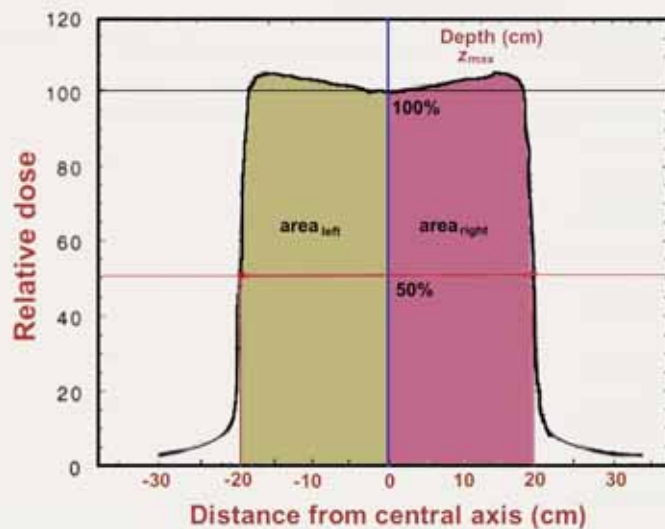

## 6.10 ISODOSE DISTRIBUTIONS IN WATER PHANTOMS

- ❑ Physical characteristics of radiation beams are usually measured in phantoms under standard conditions:
  - Homogeneous, unit density phantom
  - Flat phantom surface
  - Perpendicular beam incidence
- ❑ Central axis depth dose data in conjunction with dose profiles contain complete 2-D and 3-D information about the radiation beam.



## 6.10 ISODOSE DISTRIBUTIONS IN WATER PHANTOMS

- ❑ Planar and volumetric dose distributions are usually displayed with **isodose curves** and **isodose surfaces**, which connect points of equal dose in a volume of interest.
- ❑ The isodose curves and surfaces are usually drawn at regular intervals of absorbed dose and are expressed as a percentage of the dose at a specific reference point.



## 6.10 ISODOSE DISTRIBUTIONS IN WATER PHANTOMS

- ❑ An **isodose chart** for a given **single beam** consists of a family of isodose curves usually drawn at regular increments of PDD.
- ❑ Two normalization conventions are in use:
  - For SSD set-ups, all isodose values are normalized to 100% at point P on the central beam axis (point of dose maximum).
  - For SAD set-ups, the isodose values are normalized to 100% at the isocentre.
- ❑ The isodose charts for an SSD set-up are thus plots of PDD values; isodose charts for an SAD set-up are plots of either TAR or TMR.



## 6.10 ISODOSE DISTRIBUTIONS IN WATER PHANTOMS

- ❑ For SSD set-ups, all isodose values are normalized to 100% at point P on the central beam axis (point of dose maximum at depth  $z_{\max}$ ).

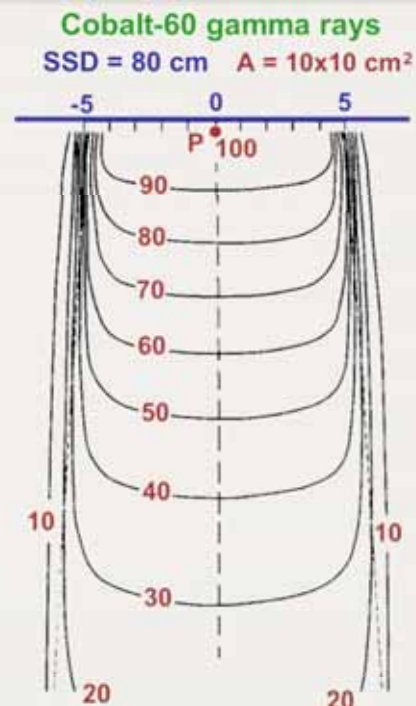
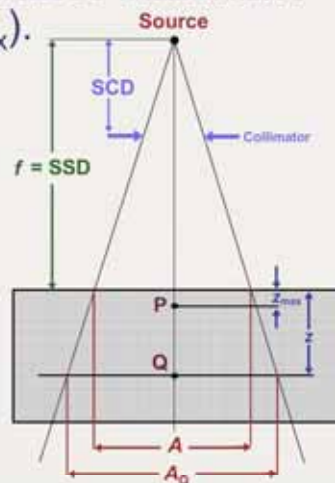



## 6.10 ISODOSE DISTRIBUTIONS IN WATER PHANTOMS

- For SAD set-ups, the isodose values are normalized to 100% at the isocentre.

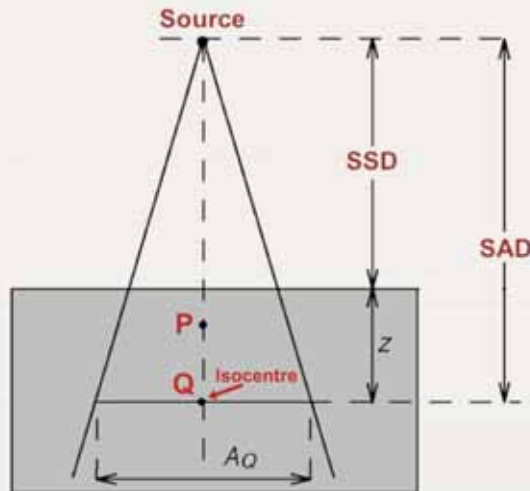

**Cobalt-60 gamma rays**  
SAD = 80 cm  $A_Q = 10 \times 10 \text{ cm}^2$

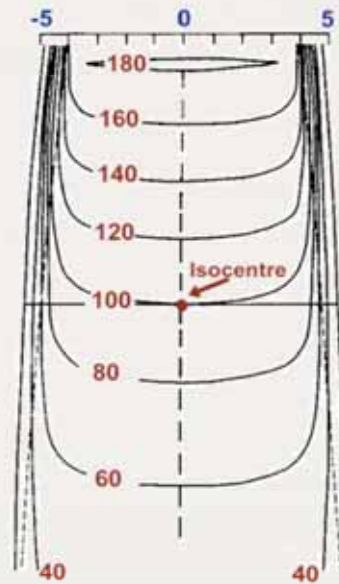

## 6.10 ISODOSE DISTRIBUTIONS IN WATER PHANTOMS

- Parameters that affect the single beam isodose distribution are:
  - Beam quality
  - Source size
  - Beam collimation
  - Field size
  - Source-skin distance
  - Source-collimator distance



## 6.10 ISODOSE DISTRIBUTIONS IN WATER PHANTOMS

- Treatment with single photon beams is seldom used except for superficial tumours treated with superficial or orthovoltage x rays.
- Deep-seated tumours are usually treated with a combination of two or more megavoltage photon beams.



## 6.10 ISODOSE DISTRIBUTIONS IN WATER PHANTOMS

- Isodose distributions for various photon radiation beams: orthovoltage x rays, cobalt-60 gamma rays, 4 MV x rays, 10 MV x rays

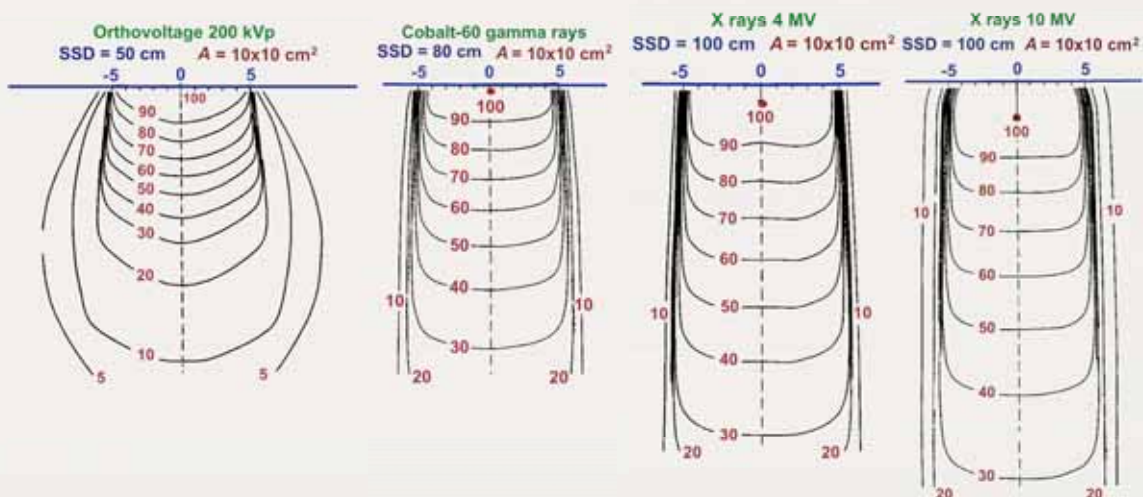

## 6.10 ISODOSE DISTRIBUTIONS IN WATER PHANTOMS

- ❑ Isodose charts are measured with:
  - Ionization chambers
  - Solid state detectors such as diodes
  - Standard radiographic film
  - Radiochromic film
  
- ❑ In addition to direct measurements, isodose charts may also be generated by calculations using various algorithms for treatment planning, most commonly with commercially available treatment planning systems (TPSs).



## 6.11 SINGLE FIELD ISODOSE DISTRIBUTIONS IN PATIENTS

- ❑ Phantom measurements are normally characterized by:
  - Flat phantom surface
  - Perpendicular beam incidence
  - Homogeneous, unit density phantom



## 6.11 SINGLE FIELD ISODOSE DISTRIBUTIONS IN PATIENTS

- Clinical situations are usually more complex:
  - The patient's surface may be curved or of irregular shape, requiring corrections for **contour irregularities**.
  - The beam may be obliquely incident on patient's surface requiring corrections for **oblique beam incidence**.
  - Some tissues such as lung and bone have densities that differ significantly from that of water, requiring corrections for **tissue heterogeneities** (also called **inhomogeneities**).



## 6.11 SINGLE FIELD ISODOSE DISTRIBUTIONS IN PATIENTS

- Isodose distributions in patients are determined by one of two radically different approaches:
  - **Correction-based algorithms** use depth dose data measured in water phantoms with a flat surface and normal incidence in conjunction with various methods to correct for irregular patient contours, oblique beam incidence, and different tissue densities.
  - **Model-based algorithms** obviate the correction problem by modeling the dose distributions from first principles and accounting for all geometrical and physical characteristics of the particular patient and treatment.



## 6.11 SINGLE FIELD ISODOSE DISTRIBUTIONS IN PATIENTS

### 6.11.1 Corrections for irregular contours and beam obliquity

- ❑ A radiation beam striking an irregular or sloping patient surface produces an isodose distribution that differs from the standard distributions obtained with normal beam incidence on a flat phantom surface.
- ❑ Two approaches are used to deal with this problem:
  - The flat phantom / normal incidence isodose distribution is corrected numerically to obtain the actual dose distribution in the patient.
  - To achieve flat phantom / normal incidence distributions in a patient the physical effect can be compensated for through the use of wedges, bolus materials or special compensators.



## 6.11 SINGLE FIELD ISODOSE DISTRIBUTIONS IN PATIENTS

### 6.11.1 Corrections for irregular contours and beam obliquity

- ❑ Methods for correcting the standard flat surface / normal incidence isodose distributions for contour irregularities and oblique beam incidence are:
  - Effective SSD method
  - TAR or TMR method
  - Isodose shift method
- ❑ These methods are applicable for:
  - Megavoltage x rays with angles of incidence up to  $45^\circ$ .
  - Orthovoltage beams with angles of incidence up to  $30^\circ$ .



## 6.11 SINGLE FIELD ISODOSE DISTRIBUTIONS IN PATIENTS

### 6.11.1 Corrections for irregular contours and beam obliquity

#### Effective SSD method

- $PDD_{\text{corr}}$  at point S is normalized to 100% dose at point P on the beam central axis and calculated from:

$$PDD_{\text{corr}} = PDD'(z, A, f, h\nu) \left( \frac{f + z_{\text{max}}}{f + h + z_{\text{max}}} \right)^2$$

- $PDD'(z, A, f, h\nu)$  is the PDD under standard conditions with the flat surface  $CC'$ .
- Parameter  $h$  is the thickness of missing tissue, while parameter  $-h$  represents the thickness of excess tissue.

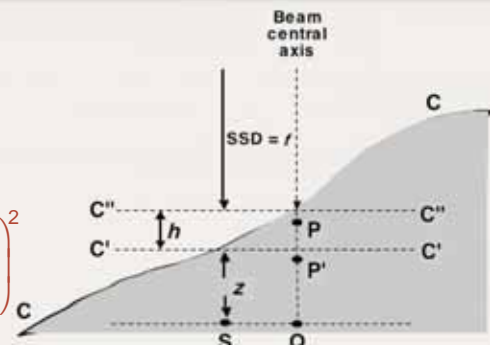

## 6.11 SINGLE FIELD ISODOSE DISTRIBUTIONS IN PATIENTS

### 6.11.1 Corrections for irregular contours and beam obliquity

- **Effective SSD method for determination of dose at arbitrary point S in patient:**

- The isodose chart is shifted to the flat surface level at the  $CC'$  contour.
- The PDD value for point S is read to get  $PDD'$ .
- The reading is corrected by an inverse square factor.

$$PDD_{\text{corr}} = PDD'(z, A, f, h\nu) \left( \frac{f + z_{\text{max}}}{f + h + z_{\text{max}}} \right)^2$$

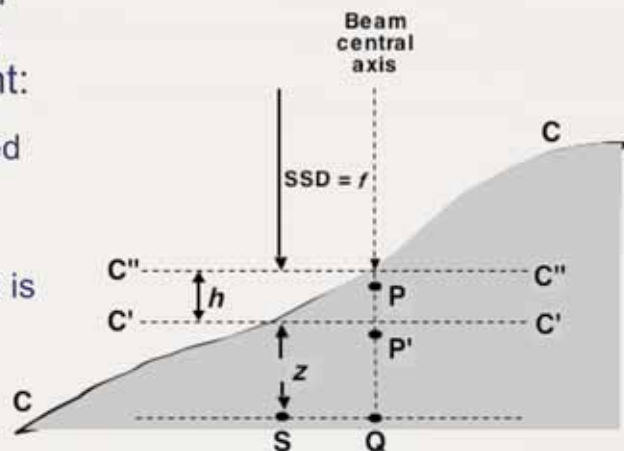



## 6.11 SINGLE FIELD ISODOSE DISTRIBUTIONS IN PATIENTS

### 6.11.1 Corrections for irregular contours and beam obliquity

#### TAR method or TMR method

- $PDD_{\text{corr}}$  is given as:

$$PDD_{\text{corr}} = PDD''(z + h, A, f, h\nu) \frac{T(z, A_Q, h\nu)}{T(z + h, A_Q, h\nu)}$$

- $A_Q$  is the field size at point S at a distance  $(f + h + z)$  from the source.
- $T$  stands for either TAR or TMR, and an assumption is made that TARs and TMRs do not depend on SSD.
- $PDD''$  represents the PDD at depth  $(h + z)$  for a standard flat phantom with the surface at  $C''C''$ .
- Parameter  $h$  is missing (positive  $h$ ) or excessive (negative  $h$ ) tissue.

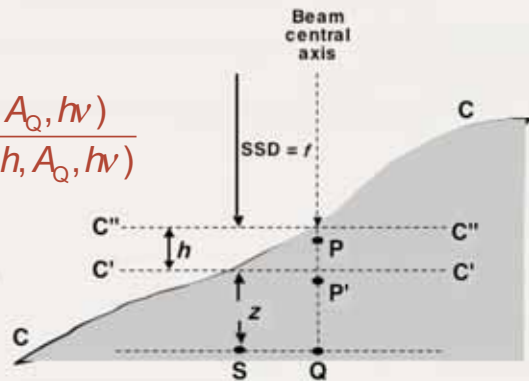

## 6.11 SINGLE FIELD ISODOSE DISTRIBUTIONS IN PATIENTS

### 6.11.1 Corrections for irregular contours and beam obliquity

#### Isodose shift method

- The value of the dose at point S is shifted on a line parallel to the beam central axis by  $(h \times k)$ .

- Parameter  $h$  is the thickness of missing (+) or excess (-) tissue.
- For missing tissue ( $h > 0$ ) the isodose is shifted away from the source; for excess tissue ( $h < 0$ ) the isodose is shifted toward the source.
- Parameter  $k$  depends on beam energy and is smaller than 1.

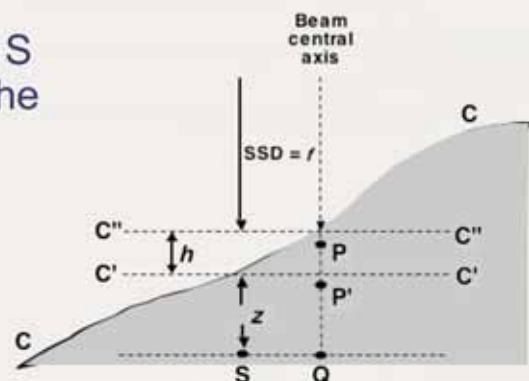

Beam quality	$k$
Co-60 to 5 MV	0.7
5 MV to 15 MV	0.6
15 MV to 30 MV	0.5



## 6.11 SINGLE FIELD ISODOSE DISTRIBUTIONS IN PATIENTS

### 6.11.2 Missing tissue compensation

- **Wedge filters** are used to even out the isodose surfaces for photon beams striking relatively flat patient surfaces under an oblique beam incidence.
- Two types of wedge filter are in use:
  - **Physical wedge** is made of lead, brass, or steel. When placed in a radiation beam, the wedge causes a progressive decrease in the intensity across the beam and a tilt of isodose curves under normal beam incidence.
  - **Dynamic wedge** provides the wedge effect on isodose curves through a closing motion of a collimator block during irradiation.



## 6.11 SINGLE FIELD ISODOSE DISTRIBUTIONS IN PATIENTS

### 6.11.2 Missing tissue compensation

- Two parameters are of importance for wedges:
  - **Wedge transmission factor** is defined as the ratio of doses at  $Z_{\max}$  in a water phantom on the beam central axis (point P) with and without the wedge.
  - **Wedge angle** is defined as the angle through which an isodose curve at a given depth in water (usually 10 cm) is tilted at the central beam axis under the condition of normal beam incidence.

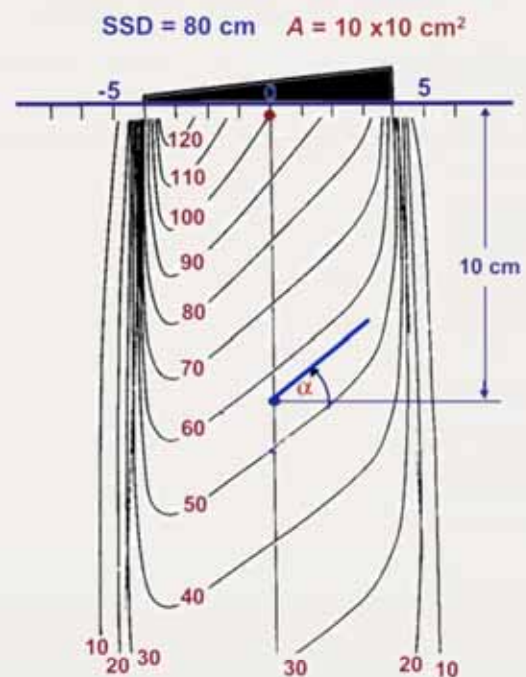

## 6.11 SINGLE FIELD ISODOSE DISTRIBUTIONS IN PATIENTS

### 6.11.2 Missing tissue compensation

- ❑ **Physical wedges** are usually available with wedge angles of 15°, 30°, 45°, and 60°.
- ❑ **Dynamic wedges** are available with any arbitrary wedge angle in the range from 0° to 60°.
- ❑ Physical wedge filters may alter the x-ray beam quality, causing
  - Beam hardening at energies of 6 - 10 MV
  - Beam softening at energies above 15 MV.



## 6.11 SINGLE FIELD ISODOSE DISTRIBUTIONS IN PATIENTS

### 6.11.2 Missing tissue compensation

- ❑ **Bolus** is tissue equivalent material placed directly onto the patient's skin surface:
  - To even out irregular patient contour.
  - To provide a flat surface for normal beam incidence.
- ❑ In principle, the use of bolus is straightforward and practical; however, it suffers a serious drawback: for megavoltage photon beams it results in the **loss of the skin sparing effect in the skin covered with the bolus** (i.e., skin sparing effect occurs in the bolus rather than in the patient).



## 6.11 SINGLE FIELD ISODOSE DISTRIBUTIONS IN PATIENTS

### 6.11.2 Missing tissue compensation

- ❑ **Compensators** are used to produce the same effect as the bolus yet preserve the skin sparing effect of megavoltage photon beams.
- ❑ Compensator is a custom-made device that mimics the shape of the bolus but is placed in the radiation beam at some 15 - 20 cm from the skin surface to preserve the skin sparing properties of the radiation beam.



## 6.11 SINGLE FIELD ISODOSE DISTRIBUTIONS IN PATIENTS

### 6.11.2 Missing tissue compensation

- ❑ Typical **compensator materials** are:
  - Lead
  - Special low melting point alloys such as Cerrobend (Lipowitz's metal).
  - Water equivalent materials such as wax.
- ❑ Since compensators are placed at some distance from the skin surface, their shape must be adjusted for:
  - Beam divergence
  - Linear attenuation coefficient of the compensator material.
  - Reduction in scatter at various depths in patient.



## 6.11 SINGLE FIELD ISODOSE DISTRIBUTIONS IN PATIENTS

### 6.11.3 Corrections for tissue inhomogeneities

- ❑ Radiation beams used in patient treatment traverse various tissues that may differ from water in density and atomic number.
- ❑ This may result in isodose distributions that differ significantly from those obtained with water phantoms.
- ❑ The effects of inhomogeneities on the dose distributions depend upon:
  - Amount, density and atomic number of the inhomogeneity.
  - Quality of the radiation beam.



## 6.11 SINGLE FIELD ISODOSE DISTRIBUTIONS IN PATIENTS

### 6.11.3 Corrections for tissue inhomogeneities

- ❑ The effects of **inhomogeneities** on dose distributions fall into two distinct categories:
  - Those that increase or decrease the attenuation of the primary beam and this affects the distribution of the scattered radiation.
  - Those that increase or decrease the secondary electron fluence.
- ❑ Three separate regions are considered with regard to inhomogeneities:
  - Region (1): the point of interest is **in front of the inhomogeneity**.
  - Region (2): the point of interest P is **inside the inhomogeneity**.
  - Region (3): Point of interest P is **beyond the inhomogeneity**.



## 6.11 SINGLE FIELD ISODOSE DISTRIBUTIONS IN PATIENTS

### 6.11.3 Corrections for tissue inhomogeneities

#### □ Region (1), point $P_1$ :

The dose is not affected by the inhomogeneity, since the primary beam is not affected and neither is the scatter component.

#### □ Region (2), point $P_2$ :

The dose is mainly affected by changes in the secondary electron fluence and to a lesser extent by changes in the primary beam attenuation.

#### □ Region (3), point $P_3$ :

The dose is mainly affected by changes in the primary beam attenuation and less by changes in scatter.

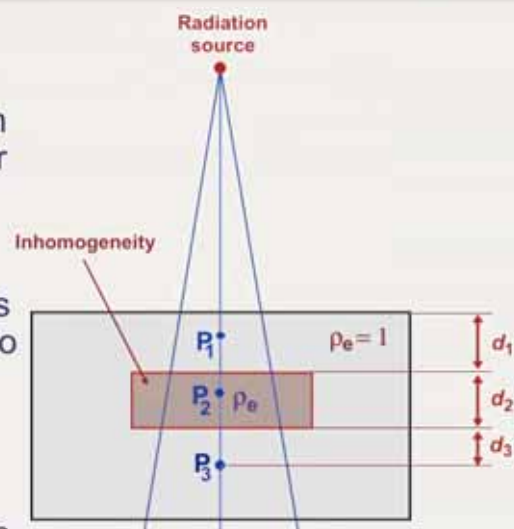

## 6.11 SINGLE FIELD ISODOSE DISTRIBUTIONS IN PATIENTS

### 6.11.3 Corrections for tissue inhomogeneities

□ Four empirical methods have been developed for correcting the water phantom dose to obtain the dose at points  $P_3$  in region (3) beyond the inhomogeneity:

- TAR method
- Power law TAR method
- Equivalent TAR method
- Isodose shift method

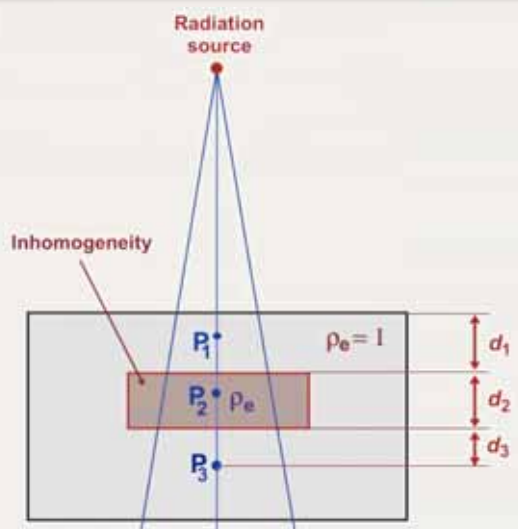

## 6.11 SINGLE FIELD ISODOSE DISTRIBUTIONS IN PATIENTS

### 6.11.3 Corrections for tissue inhomogeneities

- ❑ Beyond healthy lung (density  $\sim 0.3 \text{ g/cm}^3$ ) the dose in soft tissues will increase, while at depths beyond bone (density  $1.6 \text{ g/cm}^3$ ) the dose in soft tissue will decrease
- ❑ In comparison with dose measured in a uniform phantom, the dose in soft tissue:
  - Will increase beyond healthy lung (density  $\sim 0.3 \text{ g/cm}^3$ ).
  - Will decrease beyond bone (density  $\sim 1.6 \text{ g/cm}^3$ ).



## 6.11 SINGLE FIELD ISODOSE DISTRIBUTIONS IN PATIENTS

### 6.11.3 Corrections for tissue inhomogeneities

- ❑ Typical corrections per cm for dose beyond **healthy lung** are:

	4%	3%	2%	1%
for	Co-60	4 MV	10 MV	20 MV
- ❑ Shielding effect of **bone** depends strongly on beam energy:
  - The effect is significant at low x-ray energies because of a strong photoelectric effect presence
  - The effect is essentially negligible in the low megavoltage energy range where Compton effect predominates
  - The effect begins to increase with energy at energies above 10 MV as a result of pair production.





## 6.11 SINGLE FIELD ISODOSE DISTRIBUTIONS IN PATIENTS

### 6.11.4 Model based algorithms

- Model based algorithms for computation of dose distribution in a patient are divided into three categories:
  - **Primary dose plus first order Compton scatter method** is rudimentary as it assumes a parallel beam of monoenergetic photons and ignores inhomogeneities and scattering above the first order.
  - **Convolution-superposition method** accounts for the indirect nature of dose deposition from photon interactions, separating the primary interactions from the transport of scattered photons and charged particles produced through primary photon interactions.
  - **Monte Carlo method** uses well established probability distributions governing the individual interactions of photons and secondary charged particles and their transport through the patient.



## 6.11 SINGLE FIELD ISODOSE DISTRIBUTIONS IN PATIENTS

### 6.11.4 Model based algorithms

- **Monte Carlo simulation can be used directly to compute photon dose distributions for a given patient and treatment geometry.**
- The current limitation of direct Monte Carlo calculations is the time required to calculate the large number of histories needed to reduce stochastic or random uncertainties to acceptable levels.



## 6.11 SINGLE FIELD ISODOSE DISTRIBUTIONS IN PATIENTS

### 6.11.4 Model based algorithms

- ❑ Advances in computer technology will, within a few years, reduce Monte Carlo calculation times to acceptable levels and make Monte Carlo methods the standard approach to radiotherapy treatment planning.
- ❑ The electron densities for various tissues of individual patients are obtained with CT scanners or CT simulators and form an essential component of any Monte Carlo based dose distribution calculation.



## 6.12 CLARKSON SEGMENTAL INTEGRATION

- ❑ The dose functions (PDD, TMR, PSF, etc.) used in treatment planning are generally given for square fields and an assumption is made that for all non-square radiation fields (rectangular, circular, irregular) an equivalent square field can be determined.
- ❑ Determination of equivalent square field for rectangular and circular fields is simple; however, for irregular fields it can be quite difficult.



## 6.12 CLARKSON SEGMENTAL INTEGRATION

- ❑ **Clarkson segmental integration** is based on circular field data and used in determination of equivalent square field as well as various dose functions for a given irregular field.
- ❑ The Clarkson method resolves the irregular field into sectors of circular fields centred at the point of interest  $Q$  in the phantom or patient.
  - For manual calculations sector angular width is  $10^\circ$ .
  - For computer driven calculations angular width is  $5^\circ$  or less.

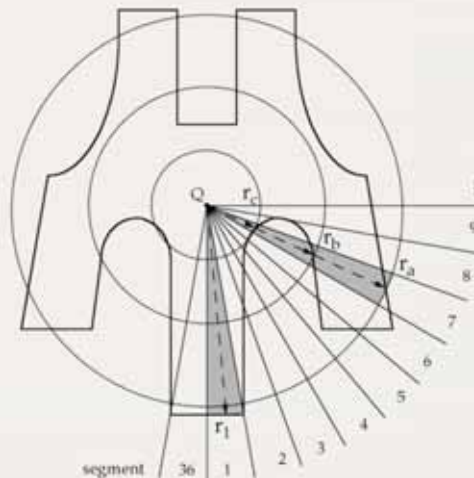

## 6.12 CLARKSON SEGMENTAL INTEGRATION

- ❑ An assumption is made that a sector with a given field radius contributes  $1/N$  of the total circular field value to the value of a given function  $F$  for the irregular field at point  $Q$ .
- ❑  $N$  is the number of sectors in a full circular field of  $360^\circ$ .
  - $N = 36$  for manual calculations.
  - $N = 72$  for computer calculations.

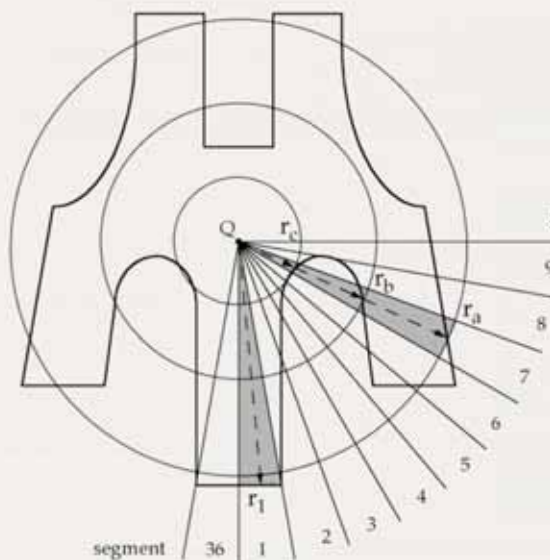

## 6.12 CLARKSON SEGMENTAL INTEGRATION

- The value of a given dose function  $F$  for an irregular field that in general depends on depth  $z$  of point  $Q$ , shape of the irregular field, SSD =  $f$ , and beam energy  $h\nu$  is then determined from the segmental integration expression:

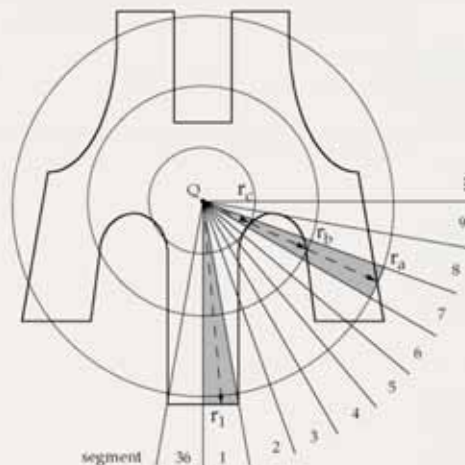

$$F(z, \text{irregular field}, f, h\nu) = \frac{1}{N} \sum_{i=1}^N F(z, r_i, f, h\nu)$$



## 6.12 CLARKSON SEGMENTAL INTEGRATION

- Two sectors are highlighted:

- **Simple sector** with contribution to the sum

$$\frac{1}{N} F(z, r_i, f, h\nu)$$

- **Composite sector** consisting of three components to yield the following contribution to the sum

$$\frac{1}{N} [F(z, r_a, f, h\nu) - F(z, r_b, f, h\nu) + F(z, r_c, f, h\nu)]$$

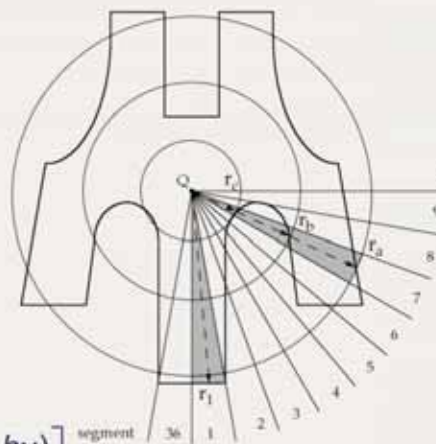

## 6.12 CLARKSON SEGMENTAL INTEGRATION

- Once the value of a dose function for a given irregular field is determined through the Clarkson integration method, the **equivalent square for the given irregular field** can be determined by finding, in tabulated square field data, the square field that will give the same value for the dose function.
- This square field is then defined as the equivalent square for the given irregular field.



## 6.12 CLARKSON SEGMENTAL INTEGRATION

- The segmental integration technique was originally proposed by **Clarkson in 1940s** and developed further by **Johns and Cunningham in 1960s** for determining the scatter component of the dose at an arbitrary point of interest in the patient, either inside or outside the direct radiation field.
- Originally, the Clarkson method was used with flat beams (orthovoltage and cobalt-60); when used with linac beams the dependence of primary beam flatness on depth in patient for off axis points must be accounted for.



## 6.13 RELATIVE DOSE MEASUREMENTS WITH IONIZATION CHAMBERS

- ❑ The dose parameters for radiotherapy treatment are most commonly measured with ionization chambers that come in many sizes and geometrical shapes.
- ❑ Usually each task of dose determination is carried out with ionization chambers designed for the specific task at hand.
- ❑ In many situations the measured chamber signal must be corrected with correction factors that depend on influence quantities, such as chamber air temperature and pressure, chamber polarity and applied voltage. and photon beam energy.



## 6.13 RELATIVE DOSE MEASUREMENTS WITH IONIZATION CHAMBERS





## 6.13 RELATIVE DOSE MEASUREMENTS WITH IONIZATION CHAMBERS

- ❑ **Doses and dose rates at reference points** in a phantom for megavoltage photon beams are measured with relatively large volume ( $0.6 \text{ cm}^3$ ) cylindrical ionization chambers in order to obtain a reasonable signal and good signal to noise ratio.



Radiation Oncology Physics: A Handbook for Teachers and Students - 6.13 Slide 3

## 6.13 RELATIVE DOSE MEASUREMENTS WITH IONIZATION CHAMBERS

- ❑ **Relative dose distributions** for photon beams beyond  $z_{\text{max}}$  are usually measured with small volume ( $0.1 \text{ cm}^3$ ) ionization chambers in order to obtain good spatial resolution.



Radiation Oncology Physics: A Handbook for Teachers and Students - 6.13 Slide 4



## 6.13 RELATIVE DOSE MEASUREMENTS WITH IONIZATION CHAMBERS

- ❑ **Surface doses** and **doses in the buildup region** are measured for photon beams with parallel-plate ionization chambers incorporating:
  - A thin polarizing electrode window to be able to measure the surface dose.
  - A small electrode separation ( $\ll 1$  mm) for better spatial resolution.
- ❑ The measured depth dose curves in the buildup region depend on chamber polarity and this dependence is called the **polarity effect** of ionization chambers.



## 6.13 RELATIVE DOSE MEASUREMENTS WITH IONIZATION CHAMBERS

- ❑ In the buildup region of megavoltage photon beams, positive parallel-plate chamber polarity produces a larger signal than the negative polarity (**polarity effect**).
- ❑ The difference in signals is most pronounced on the phantom surface and then diminishes with depth until it disappears completely at depths of  $z_{\max}$  and beyond.

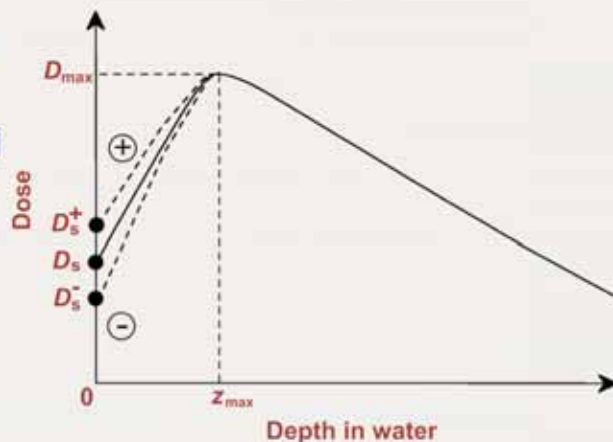

## 6.14 DELIVERY OF DOSE WITH A SINGLE EXTERNAL BEAM

- ☐ **Outputs** for x ray machines and radionuclide teletherapy units are usually given in centigray per minute (**cGy/min**) at  $z_{\max}$  in a phantom at a nominal source-surface distance SSD.
- ☐ **Outputs** for linacs are usually given in centigray per monitor unit (**cGy/MU**) at  $z_{\max}$  in a phantom at a nominal source-surface distance SSD..

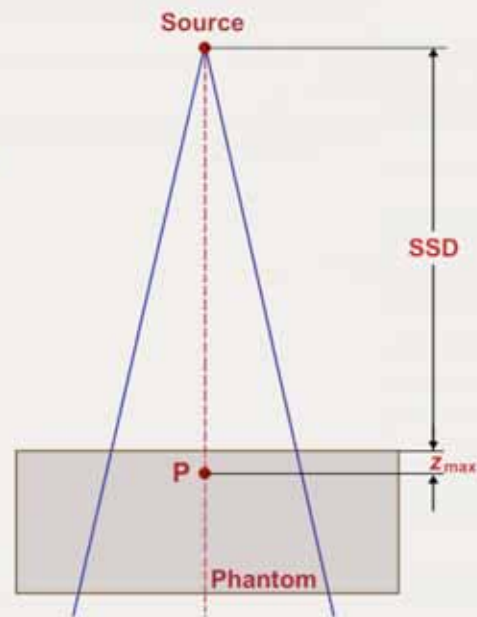

## 6.14 DELIVERY OF DOSE WITH A SINGLE EXTERNAL BEAM

- ☐ Transmission ionization chambers in linacs are usually adjusted such that the beam output (**dose rate**) corresponds to:
  - 1 cGy/MU
  - at  $z_{\max}$  in phantom (point P)
  - for a  $10 \times 10 \text{ cm}^2$  field
  - at SSD = 100 cm.

- ☐  $\dot{D}_P(z_{\max}, 10, 100, hv) = 1 \text{ cGy/MU}$

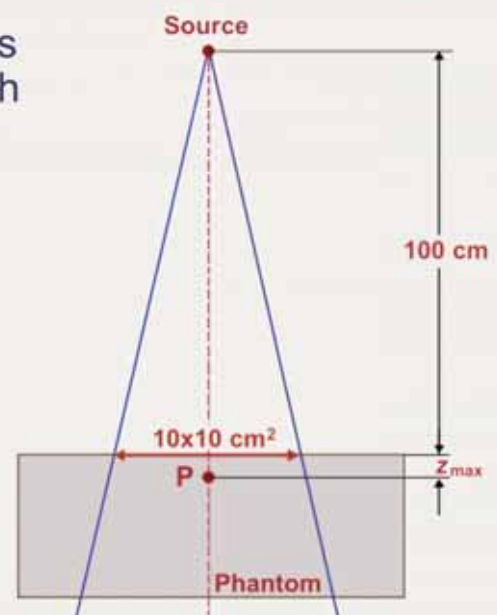

## 6.14 DELIVERY OF DOSE WITH A SINGLE EXTERNAL BEAM

- $\dot{D}_P(z_{\max}, A, 100, h\nu)$ , the dose rate at point P for an SSD of 100 cm for an arbitrary field size A is obtained by multiplying

$$\dot{D}_P(z_{\max}, 10, 100, h\nu) = 1 \text{ cGy/MU}$$

with the relative dose factor

RDF(A, hν):

$$\begin{aligned} \dot{D}_P(z_{\max}, A, 100, h\nu) &= \\ &= \dot{D}_P(z_{\max}, 10, 100, h\nu) \times \\ &\text{RDF}(A, h\nu) \end{aligned}$$

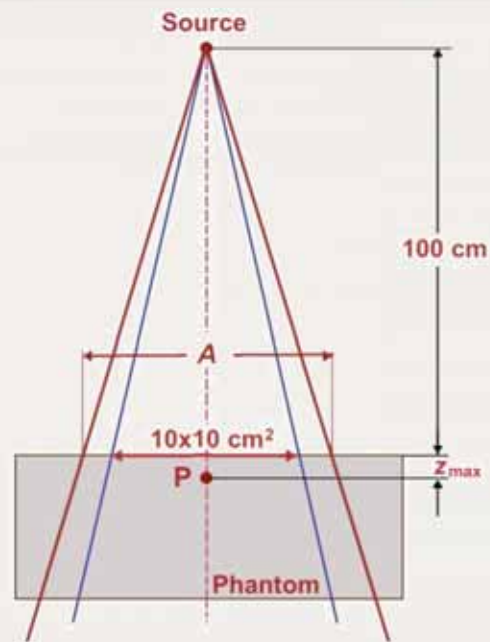

## 6.14 DELIVERY OF DOSE WITH A SINGLE EXTERNAL BEAM

- The number of monitor units MU (in MUs) required to deliver a tumour dose TD at point Q using a **single SSD field**, SSD of 100 cm, and field size A is:

$$\text{MU} = \frac{\text{TD}}{\dot{\text{TD}}} = \frac{\text{TD}}{\dot{D}_P(z_{\max}, 10, 100, h\nu) \times \text{RDF}(A, h\nu) \times \text{PDD}(z, A, f, h\nu)}$$

- Note:  $\dot{\text{TD}} = \dot{D}_Q = \dot{D}_P(z_{\max}, 10, f, h\nu) \times \text{RDF}(A, h\nu) \times \text{PDD}(z, A, f, h\nu)$

$\dot{\text{TD}}$  stands for tumour dose rate.

$$\dot{D}_P(z_{\max}, 10, 100, h\nu) = 1 \text{ cGy/MU}$$



## 6.14 DELIVERY OF DOSE WITH A SINGLE EXTERNAL BEAM

- The number of monitor units MU (in MUs) required to deliver a tumour dose TD at point Q using a **single SAD field**, SAD of 100 cm, and field size  $A_Q$  is:

$$\text{MU} = \frac{\text{TD}}{\dot{D}} = \frac{\text{TD} \times \left( \frac{f + z_{\text{ref}}}{f} \right)^2}{\dot{D}_P(z_{\text{max}}, 10, 100_{\text{SSD}}, h\nu) \times \text{RDF}(A, h\nu) \times \text{TPR}(z, A_Q, h\nu)}$$

- Note:  $\dot{D}_{Q_{\text{ref}}}(z_{\text{ref}}, A_Q, 100_{\text{SAD}}, h\nu) \approx$

$$\approx \dot{D}_P(z_{\text{max}}, 10, 100_{\text{SSD}}, h\nu) \times \text{RDF}(A, h\nu) \times \left( \frac{f + z_{\text{ref}}}{f} \right)^2$$



## 6.14 DELIVERY OF DOSE WITH A SINGLE EXTERNAL BEAM

$$\dot{D}_P(z_{\text{max}}, 10, 100, h\nu) = 1 \text{ cGy/MU}$$

$$\dot{D}_P(z_{\text{max}}, A, 100, h\nu) = \dot{D}_P(z_{\text{max}}, 10, 100, h\nu) \times \text{RDF}(A, h\nu)$$

For  $z_{\text{ref}} = z_{\text{max}}$ ,

$\text{TPR} = \text{TMR}$

and  $\dot{D}_{Q_{\text{ref}}} = \dot{D}_{Q_{\text{max}}}$

$$\dot{D}_{Q_{\text{ref}}}(z_{\text{ref}}, A_Q, 100_{\text{SAD}}, h\nu) \approx$$

$$\approx \dot{D}_P(z_{\text{max}}, 10, 100_{\text{SSD}}, h\nu) \times \text{RDF}(A, h\nu) \times \left( \frac{f + z_{\text{ref}}}{f} \right)^2$$

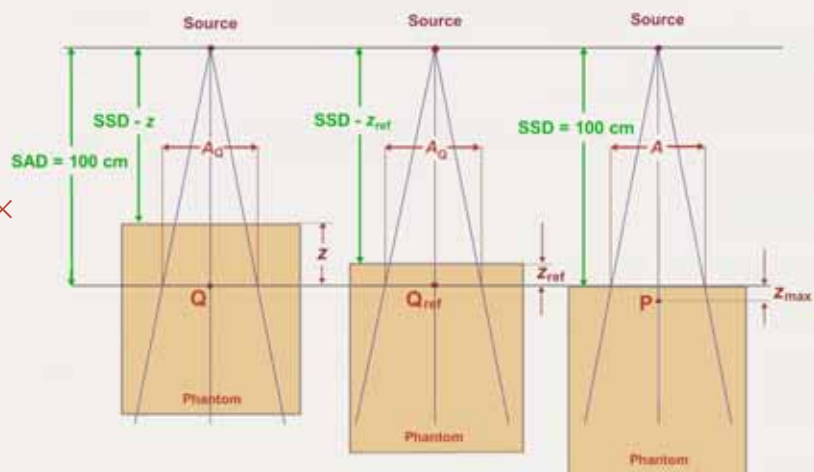

## 6.15 EXAMPLE OF DOSE CALCULATION

- Given  $\dot{D}(z, A, f, Co) = \dot{D}(15, 15, 80, Co)$  calculate  $\dot{D}(10, 20, 140, Co)$  :

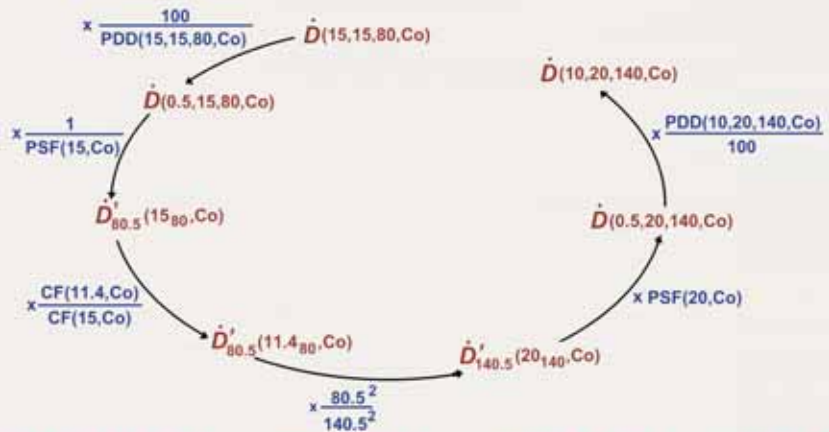

General answer  
for SSD approach:

$$\frac{\dot{D}(10, 20, 140, Co)}{\dot{D}(15, 15, 80, Co)} = \frac{PDD(10, 20, 140, Co)}{PDD(15, 15, 80, Co)} \times \frac{PSF(20, Co)}{PSF(15, Co)} \times \frac{CF(11.4, Co)}{CF(15, Co)} \times \left( \frac{80.5}{140.5} \right)^2$$



## 6.15 EXAMPLE OF DOSE CALCULATION

- Given  $\dot{D}(z, A, f, Co) = \dot{D}(15, 15, 80, Co)$  calculate  $\dot{D}(10, 20, 140, Co)$ :

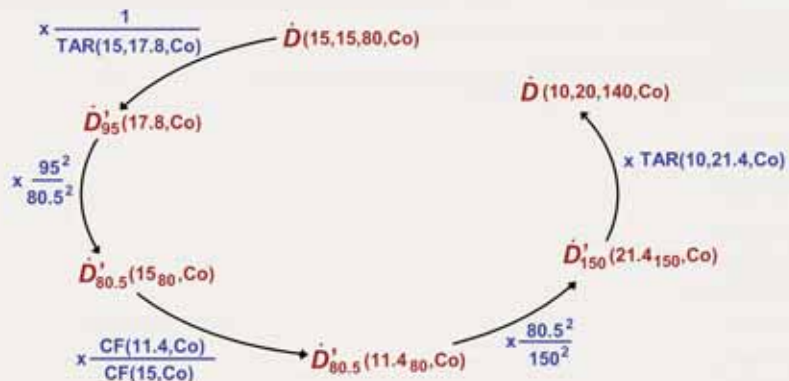

General answer  
for SAD approach:

$$\frac{\dot{D}(10, 20, 140, Co)}{\dot{D}(15, 15, 80, Co)} = \frac{TAR(10, 21.4, Co)}{TAR(15, 17.8, Co)} \times \frac{CF(11.4, Co)}{CF(15, Co)} \times \left( \frac{95}{150} \right)^2$$



## 6.16 SHUTTER CORRECTION TIME

- ❑ In radiotherapy machines that use an **electrical timer** for measuring the dose delivery (radiotherapy x-ray machines and teletherapy cobalt-60 machines), account must be taken of possible end effects (**shutter correction time**) resulting from switching the beam on and off.
  - In radiotherapy x-ray machines the beam output builds up from zero to its full value as the generating voltage builds up in the first few seconds of the treatment.
  - In radionuclide teletherapy machines the source is moved into position at the start of treatment and is returned to its safe position at the end of treatment causing end effects in beam output.



## 6.16 SHUTTER CORRECTION TIME

- ❑ The **shutter correction time**  $\tau_s$  is defined as the time that must be added to, or subtracted from, the calculated treatment time  $T_c$  to deliver accurately the prescribed dose to the patient.
- ❑ For a given timer-controlled radiotherapy machine the shutter correction time is typically determined by measuring two doses ( $D_1$  and  $D_n$ ) at a given point Q in a phantom.



## 6.16 SHUTTER CORRECTION TIME

- The **shutter correction time**  $\tau_s$  is typically determined by measuring two doses ( $D_1$  and  $D_n$ ) at a given point Q in a phantom:
  - $D_1$  is measured with a relatively long exposure time  $T$  (of the order of 5 min), contains one end effect and is governed by:

$$D_1 = \dot{D}(T + \tau_s) \quad \text{or} \quad \dot{D} = \frac{D_1}{T + \tau_s}$$

- $D_n$  is measured cumulatively with  $n$  dose segments, each having an exposure time  $T/n$ . The dose  $D_n$  thus contains  $n$  end effects; the cumulative beam-on time is again equal to  $T$ , and  $D_n$  is:

$$D_n = \dot{D}(T + n\tau_s) \quad \text{or} \quad \dot{D} = \frac{D_n}{T + n\tau_s}$$



## 6.16 SHUTTER CORRECTION TIME

- Solving the equation for the true dose rate  $\dot{D}$

$$\dot{D} = \frac{D_1}{T + \tau_s} = \frac{D_n}{T + n\tau_s}$$

- The **shutter correction time** is:  $\tau_s = \frac{(D_n - D_1)T}{(nD_1 - D_n)}$ 
  - For  $D_n > D_1$ ,  $\tau_s > 0$
  - For  $D_n = D_1$ ,  $\tau_s = 0$
  - For  $D_n < D_1$ ,  $\tau_s < 0$
- **Typical shutter correction times are of the order of 1 s.**

